

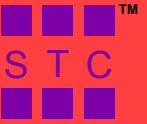

Stainless Steel Pilot Piston Solenoid Valve 2MS Series for High Temperature & High Pressure



To Order, Please Specify: 1. Model No, 2. Voltage, 3. Pressure Option

	Part No.	Voltage	Pressure Option	Port Size (NPT or Flange)	Orifice (MM)	Cv	Power (W)	Features	
 <p>2 Way, NC Pilot Piston Stainless Steel</p>	2MS120 - 3/8	Voltage Options: 1 = 12 VDC 2 = 24VDC	M Option: DC: 6 to 580 PSI AC: 6 to 725 PSI H Option: 87 to 1450 PSI	3/8	12	4.5	20W 22VA	Normally Closed, 2 Way, Pilot Piston Operation Operating Pressure: Standard: 6 to 230 PSI Options: Medium DC: 6 to 580 PSI Medium AC: 6 to 725 PSI High: 87 to 1160 PSI Fluid Temperature: -20°C to 180°C Ambient Temperature: -20 to 55°C Valve Material: Stainless Steel Seal: PTFE, Options: Viton Compatible Fluid: Steam, Air, Inert Gases, Water, Liquid, etc.	
	2MS150 - 1/2			1/2	15	4.5			
	2MS200 - 3/4			3/4	20	7.6			
	2MS250 - 1	1	25	12					
	2MS320 - 1 1/4	1 1/4	32	22					
	2MS400 - 1 1/2	1 1/2	40	30					
	2MS500 - 2	2	50	48					
	<p>2 Way, NO Pilot Piston Stainless Steel</p>	2MSO150 - 1/2	Voltage Options: 1 = 12 VDC 2 = 24VDC 2A=24VAC 3 = 110VAC 4 = 220VAC (50/60Hz)	M Option: DC: 6 to 580 PSI AC: 6 to 725 PSI H Option: 87 to 1160 PSI	1/2	15	4.5	30W 28VA	Normally Open, 2 Way, Pilot Piston Operation Operating Pressure: 6 to 145 PSI Fluid Temperature: -20°C to 180°C Ambient Temperature: -20 to 55°C Valve Material: Stainless Steel Seal: PTFE, Options: Viton Compatible Fluid: Steam, Air, Inert Gases, Water, Liquid, etc.
		2MSO200 - 3/4			3/4	20	7.6		
		2MSO250 - 1			1	25	12		
		2MSO320 - 1 1/4			1 1/4	32	22		
		2MSO400 - 1 1/2			1 1/2	40	30		
		2MSO500 - 2			2	50	48		

Valve Model	2MS120	2MS150	2MS200	2MS250	2MS320	2MS400	2MS500	2MSO120	2MSO150	2MSO200	2MSO250	2MSO320	2MSO400	2MSO500
Valve Type	2 Way Normally Closed (NC)							2 Way Normally Open (NO)						
Action	Pilot Piston							Pilot Piston						
Port Size (NPT)	3/8"	1/2"	3/4"	1"	1 1/4"	1 1/2"	2"	3/8"	1/2"	3/4"	1"	1 1/4"	1 1/2"	2"
Port Size (Flange)		1/2 F	3/4 F	1 F	1 1/4 F	1 1/2 F	2 F							
Cv	4.5	4.5	7.6	12	22	30	48	4.5	4.5	7.6	12	22	30	48
Orifice	12	15	20	25	32	40	50	12	15	20	25	32	40	50
Operating Pressure	Standard: 6 to 230 PSI M Option: Medium DC: 6 to 580 PSI Medium AC: 6 to 725 PSI H Option: High: 87 to 1450 PSI			Standard: 6 to 230 PSI M Option: Medium DC: 6 to 580 PSI Medium AC: 6 to 725 PSI H Option: High: 87 to 1160 PSI				Standard: 6 to 145 PSI (0.4 to 10 bar)						
Temperature	Medium: -6 to 356 °F (-20 TO 180 °C) with PTFE Seal; Ambient: -6 to 130 °F (-20 TO 55 °C) with PTFE Seal													
Body Materials	Stainless Steel													
Seal Materials:	Standard: PTFE; Options: Viton, EPDM													
Coil Protection Insulation Class	H Class IP65													
Coil Duty	100% ED (Continuous Duty)													
Coil Power	DC:20W, AC:22VA													
Electrical Connections	DIN 43650A (Form A)													
Wetted Surfaces	Stainless Steel & PTFE													
Service	Air, Inert Gas, Liquid, Steam, Vacuum													

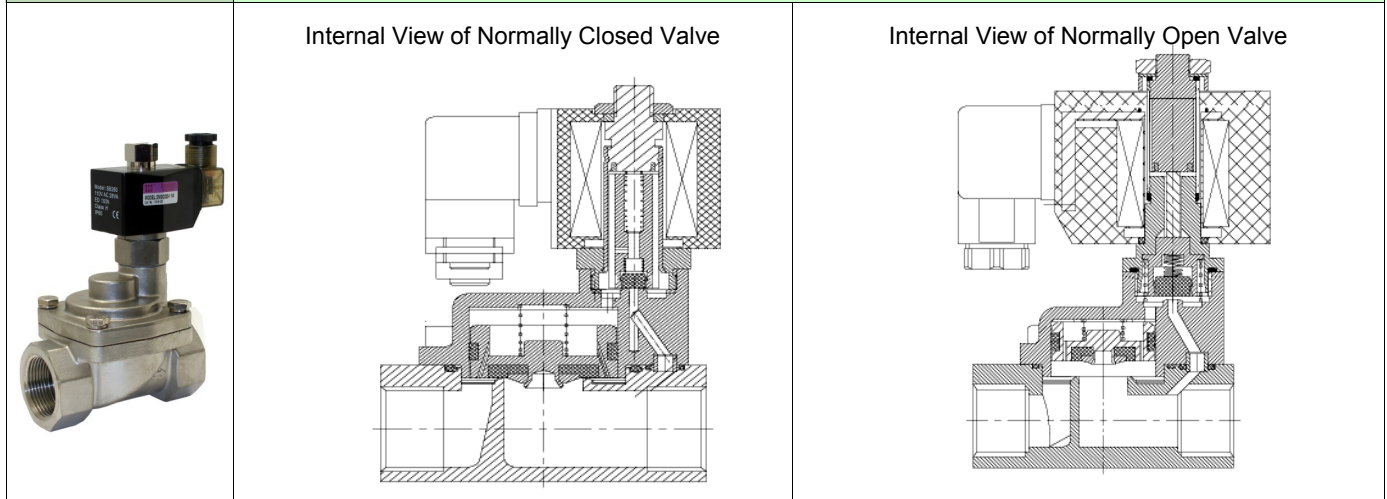

2MS/2MSO Series Stainless Steel Pilot Piston Solenoid Valve Numbering System

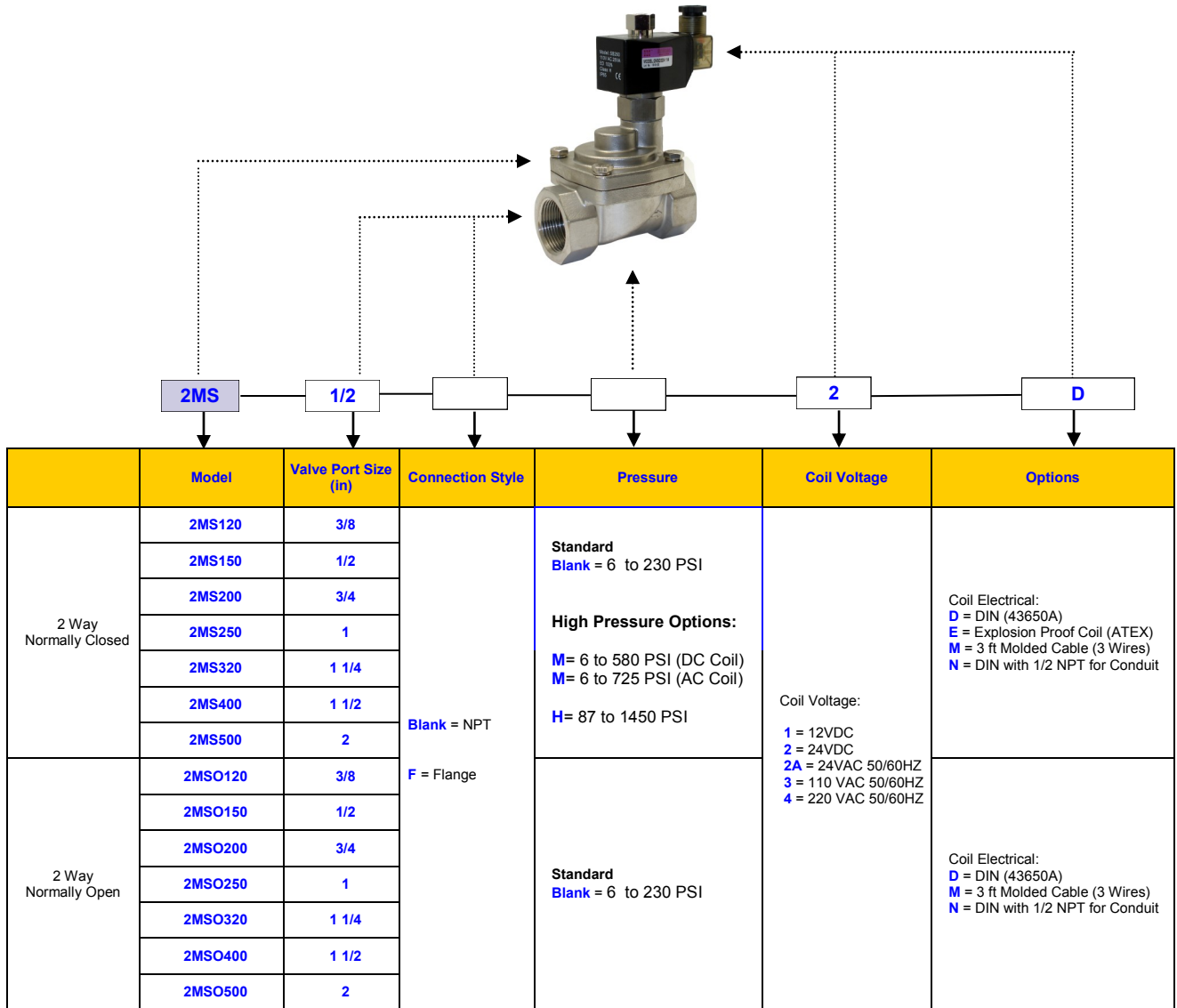

Electrical Connection Options:

M = 3 ft Molded Cable (3 Wires)

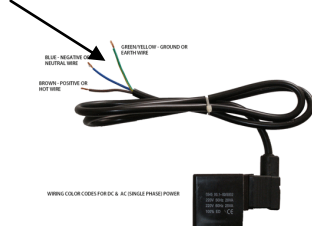

N = DIN with 1/2 NPT for Conduit D = DIN (43650A)

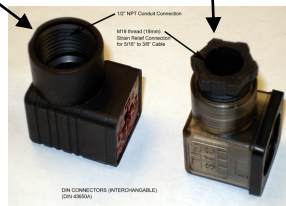

2MS & 2MSO Series Valves Internal Components

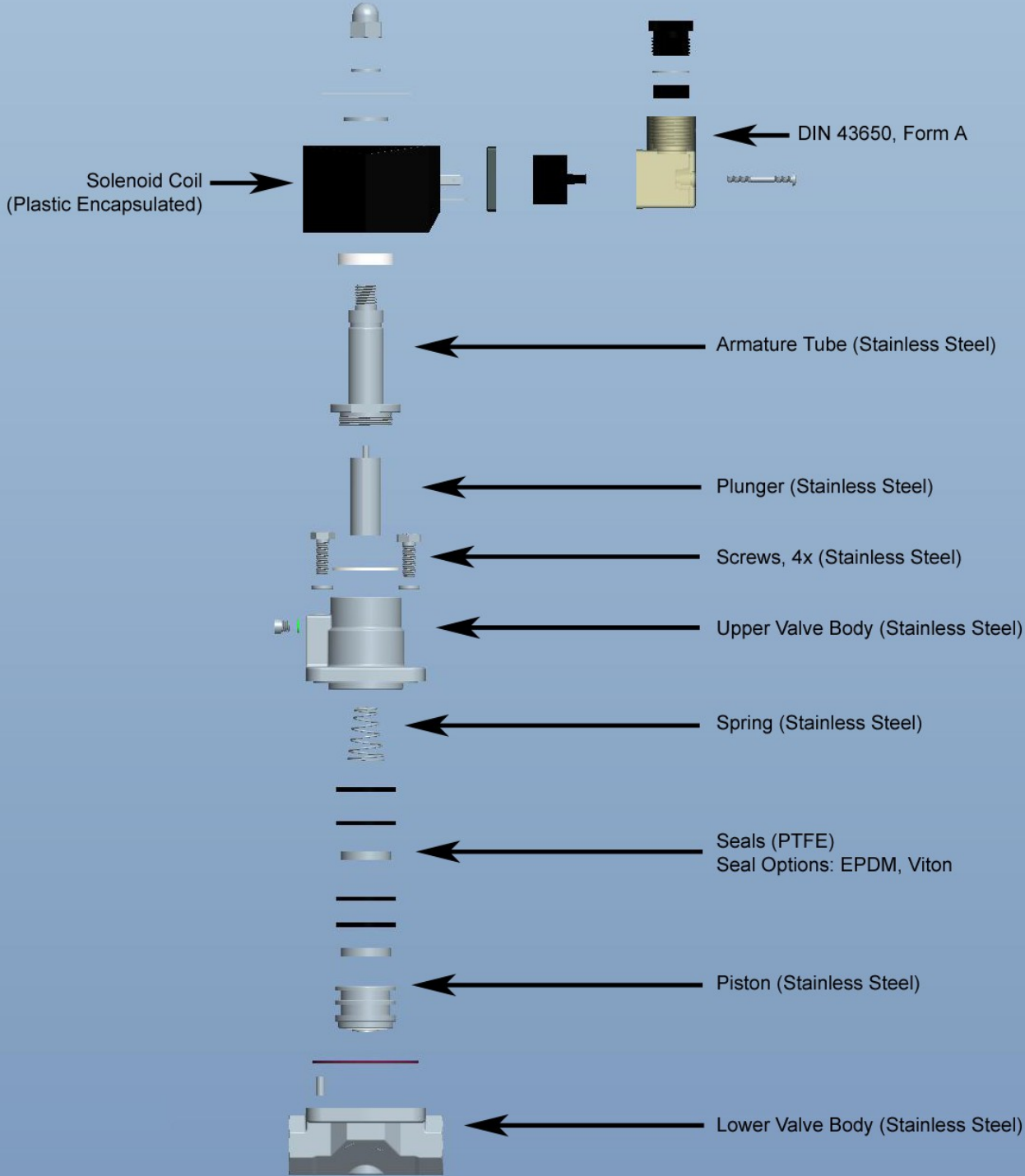

Valve Dimensions

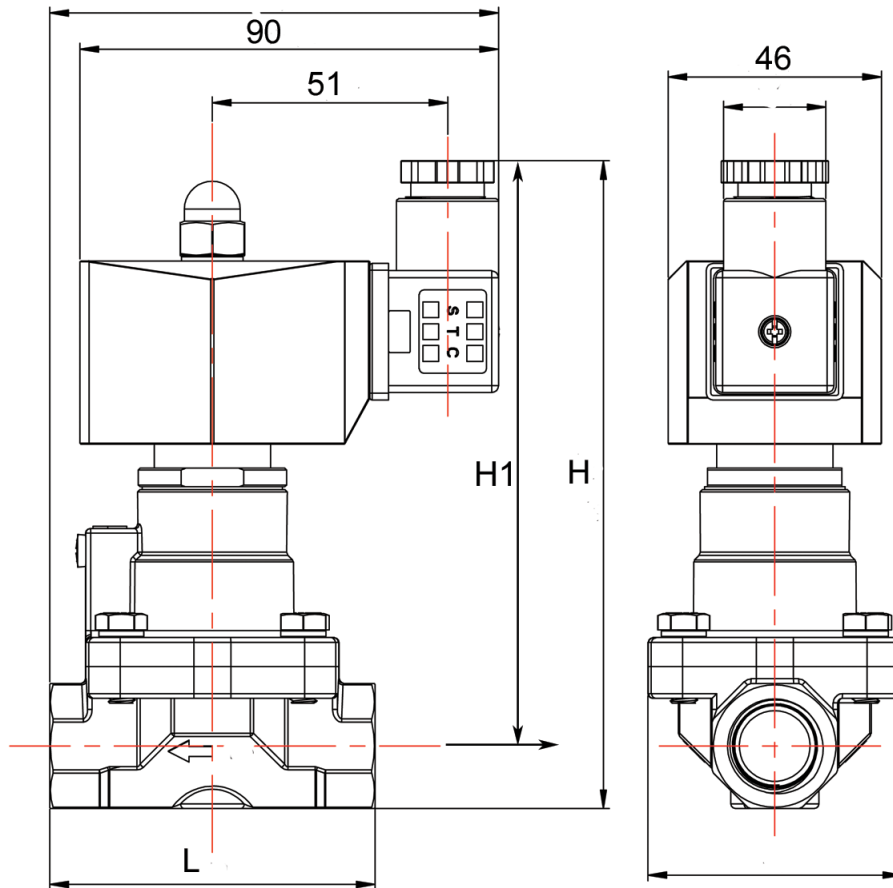

Model: 2M Series Dimensions (MM)														
Normally Closed (NC)		Normally Open (NO)		Port Size H (NPT)	Orifice	Cv	L	H1	H	Pressure (psi)		Medium Temperature	Ambient Temperature	Power Consumption
Brass	Stainless Steel	Brass	Stainless Steel							NC	NO			
2M150-1/2	2MS150-1/2	2MO150-1/2	2MSO150-1/2	1/2	15	4.5	75	117	140	6 to 230	6 to 145	-4 to 356°F	-4 to 122°F	20-30W
2M200-3/4	2MS200-3/4	2MO200-3/4	2MSO200-3/4	3/4	20	7.6	75	122	147	6 to 230	6 to 145	-4 to 356°F	-4 to 122°F	20-30W
2M250-1	2MS250-1	2MO250-1	2MSO250-1	1	25	12	92	143	155	6 to 230	6 to 145	-4 to 356°F	-4 to 122°F	20-30W
2M320-1 1/4	2MS320-1 1/4	2MO320-1 1/4	2MSO320-1 1/4	1 1/4	32	22	110	143	155	6 to 230	6 to 145	-4 to 356°F	-4 to 122°F	20-30W
2M400-1 1/2	2MS400-1 1/2	2MO400-1 1/2	2MSO400-1 1/2	1 1/2	40	30	122	145	160	6 to 230	6 to 145	-4 to 356°F	-4 to 122°F	20-30W
2M500-2	2MS500-2	2MO500-2	2MSO500-2	2	50	48	161	157	179	6 to 230	6 to 145	-4 to 356°F	-4 to 122°F	20-30W

STC 2MS150-500 SERIES VALVES WATER FLOW RATE VS PRESSURE

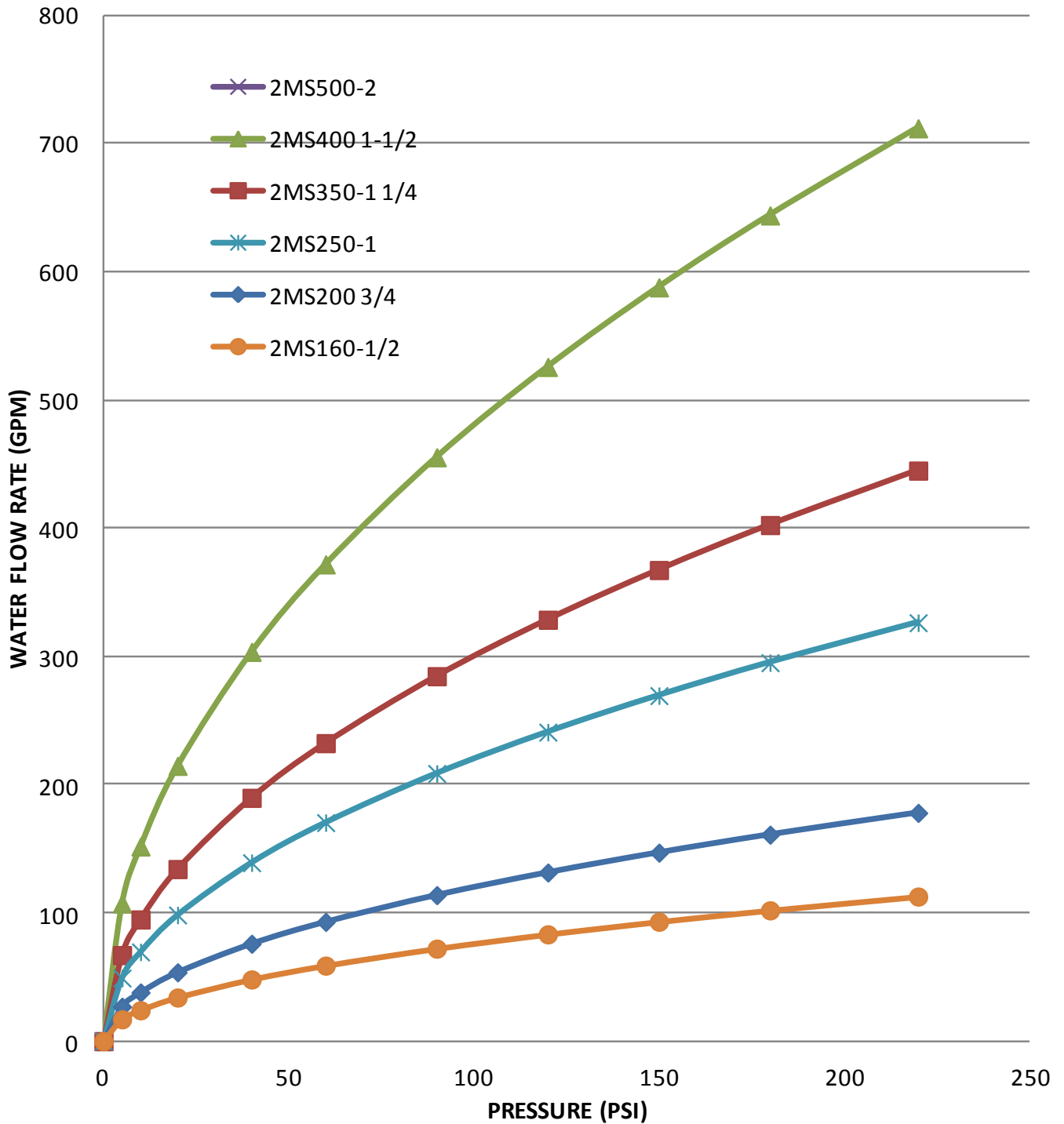

STC 2MS150-250 SERIES VALVE WATER FLOW RATE VS PRESSURE

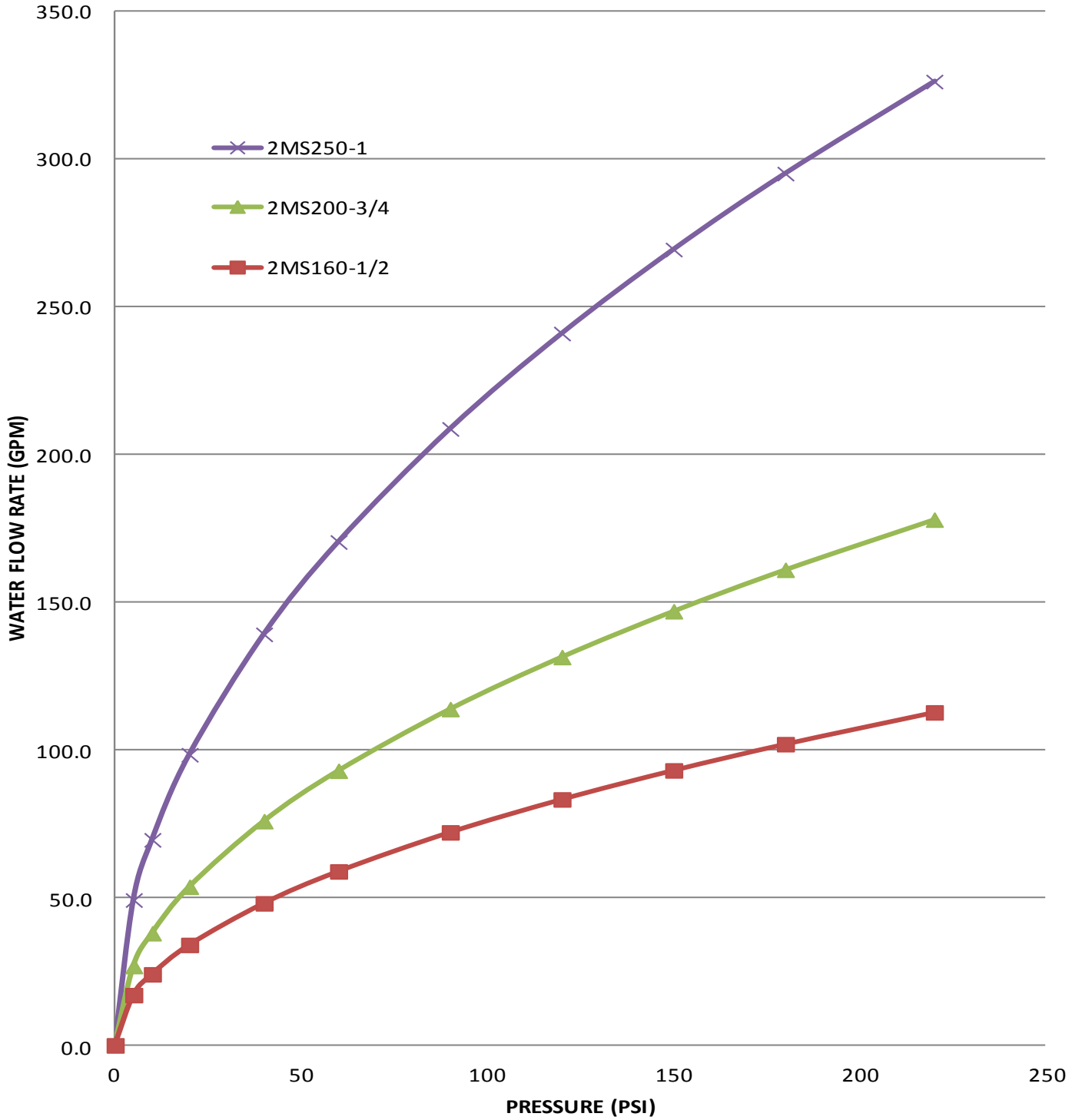

Installation and Operation:

To connect the valve Inlet and Outlet:

Connect the inlet and outlet in the direction of the arrow marked on the valve.

To install coil:

Put the coil onto the armature tube of the valve. Put the lock-washer and nut onto the armature tube. Hand tighten the nut, then use a wrench to tighten the nut to a quarter turn; **do not over-tighten the nut, it may cause the armature tube to fail pre-maturely.**

To connect DIN coil:

1. Remove the Philip screw from the plastic housing and unplug it from the DIN coil.
2. From the screw opening, push the terminal block out from the plastic housing.
3. Note the 1, 2 and ground markings on underside of DIN enclosure.
4. For DC DIN Coil, Connect 1 to Positive, 2 to Negative.
5. For AC DIN Coil, connect 1 to HOT wire, 2 to Neutral wire, and if required connect
6. **Do not energize the coil without installing it onto the valve, it will burn the coil and create fire hazards.**

Safety Note: Standard valves are supplied with continuous duty coils. The proper class of insulation for the service is indicated on the coil. The coil temperature may become hot after being energized for extended periods, but it is normal. Do not energize the coil without installing it onto the valve or connect the coil to a wrong voltage, as it may overheat and damage the coil; although the coil is made of flame retarded material, misuse of the coil in this manner could create fire hazards and generate smoke or burning odor which indicates excessive coil temperature and should disconnect the power to the coil immediately.

Operation: 2MS series valve is a 2/2 Pilot Piston, Normally Closed Solenoid Valve.

When the valve receives an electrical signal, a magnetic field is formed which attracts the plunger covering the pilot orifice to lift off and allow the media to escape into the outlet port, which causes pressure on the top of the piston to drop. As the pressure is reduced, the full system pressure on the other side of the piston acts to lift the piston away from the main orifice and allows the media to flow through the valve. Since the bleed orifice in the piston is dimensionally smaller than the pilot orifice, the system pressure cannot rebuild on the top of the piston as long as the pilot orifice remains open.

When the valve is de-energized, it releases its hold on the plunger. Then the plunger forced by the spring drops and covers the pilot orifice. As the media enters through the piston bleed orifice into the top side of the piston, it causes the pressure to build up and forces the piston down until it covers the main orifice and stops media flow through the valve.

These valves are equipped with Teflon (PTFE) seals which is not elastic but is formable. It is because of this seal property, if the valve is used in low temperature, there may be small leak and the valve needs to be break-in to form a good mating surface between the seal and the valve orifice. Although the valve have been break-in at the factory level to make sure there is no leak, but due to shipping and installation, the break-in mating surface may have shifted and needs to break-in again, and this is very common. This is accomplished by cycling the valve ON/OFF quickly at the operating pressure until no leak is observed.

The 2MS series valve is to be used with clean media. If the pilot hole is block, use the cleaning procedure to clean the pilot hole.

Valve Pilot Hole Cleaning Procedure

The 2MS series valve is to be used with clean media. If the valve does not open or close properly, the pilot holes inside the valve may be block or restricted. Use the following cleaning procedure to clean the pilot hole.

1. Remove the coil from the valve body.
2. Remove the 4 socket head machine screws from the valve.
3. Remove the top valve cover.
4. Put a small wire through the hole in the valve cover as shown below. Try to dislodge and remove any small particles got trap inside the small pilot hole.
5. Put a small wire through the hole in the valve piston as shown below. Try to dislodge and remove any small particles got trap inside the small pilot hole.
6. Reassemble the valve and test the valve to assure that it is functioning properly before returning it to service.

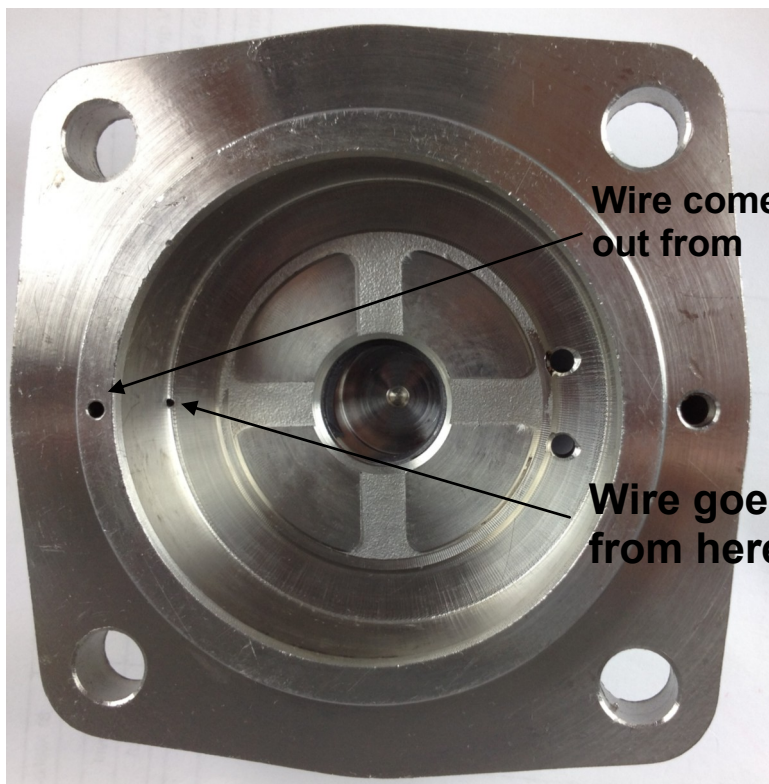

VALVE COVER

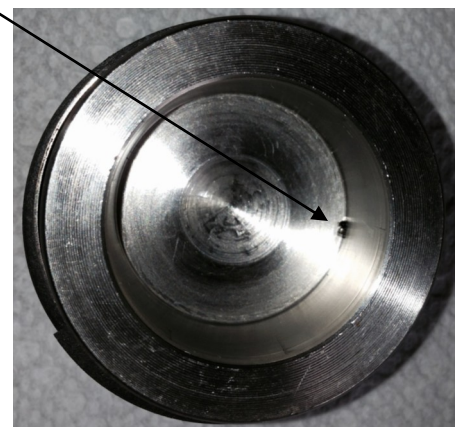

VALVE PISTON

Valve Pilot Hole Cleaning Procedure

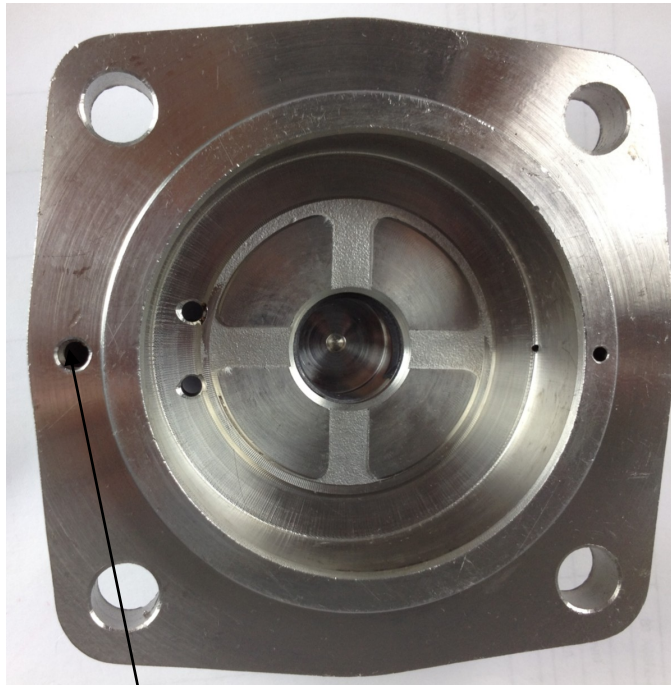

During re-assembling of the valve, make sure the large hole on the top half of the valve lines up with the hole on the bottom half of the valve

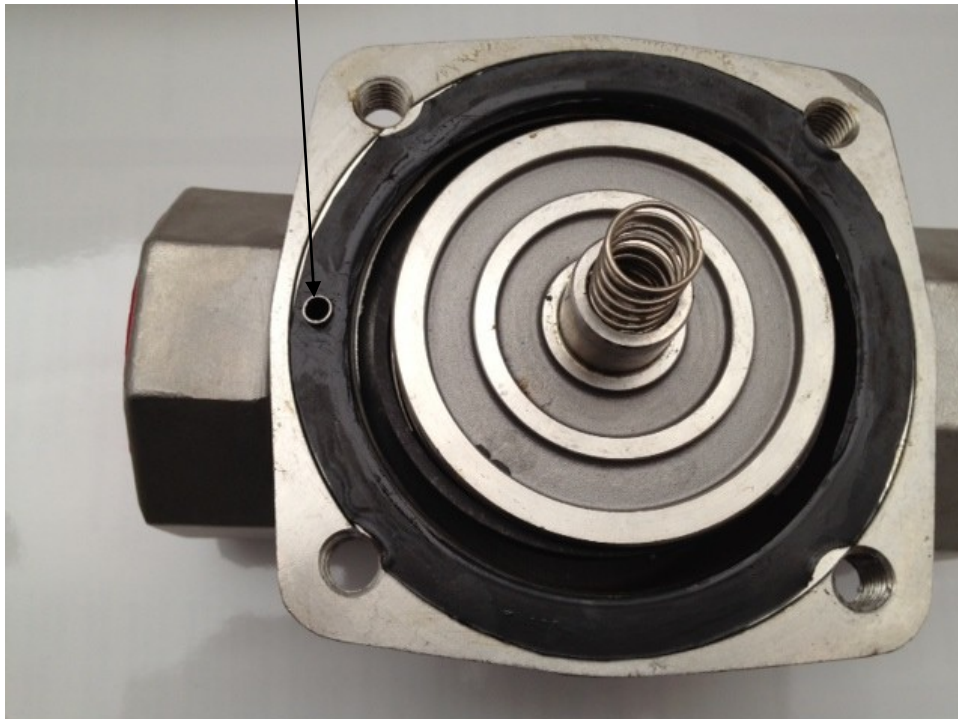

Terms and Conditions

By purchasing from SIZTO TECH CORPORATION (STC), you agree to these TERMS AND CONDITIONS. No other terms shall apply except as agreed in writing signed by us. We reserve the right to correct typographic errors and reject orders.

SHIPMENTS:

All shipments are F.O.B. 892 Commercial Street, Palo Alto, CA 94303, USA. Most orders are shipped via UPS Standard Ground unless instructions accompany order. Outside the UPS zones, shipment will be made Best Way. The responsibility for goods delay, lost or damaged in transit rests with the carrier and purchaser. Purchaser may purchase shipping insurance to cover lost or damaged products caused by shipping.

RETURN OF MERCHANDISE:

No merchandise is accepted for return 30 days after delivery date. No credit allowed on merchandise shipped as ordered and returned without obtaining an authorization number IN ADVANCE. A 20% restocking charge applies to all returns, and transportation charges must be fully prepaid. We will pay **ground** transportation charges on re-sent or returned merchandise due to STC's error.

Shortages & Mis-Shipments: Any shortages or mis-shipment must be reported within 15 days.

CANCELLATION POLICY:

Blanket order can be canceled 90 days before scheduled ship date. There will be a 10% charge if a blanket order is cancel within 90 days of scheduled ship date, and a 20% charge if cancel within 60 days. Regular order for non-custom parts can be canceled any time before the order is shipped. For custom parts, a 30% down payment is required either at the time of order or 90 days prior to scheduled ship date, whichever comes later.

Remittances should be sent to:

Sizto Tech Corporation, 892 Commercial Street, Palo Alto, CA 94303, USA

Credit Card Payments: Visa, MasterCard, Discover, or American Express Accepted

International Customers: Advance Payment Required via Bank Wire, Cashier's Check or Approved Credit Card.

Credit Application: To establish a net 30 day account, please mail or fax three trade references with complete mailing addresses and account numbers.

LIMITED WARRANTY – IMPORTANT NOTICE TO PURCHASER:

Sizto Tech Corporation (STC) only warrants this product to be free from defects in materials and workmanship at the time of shipment. This limited warranty expires one year after delivery to the end-user. STC's entire obligation to the Purchaser for breach of this limited warranty shall be limited to replacement of the defective product or refund of the original purchase price of this product, at STC's option. Purchaser has thirty (30) days to return the goods after STC has agreed to accept the return. All freight charges on returned material shall be paid by the Purchaser. STC's limited warranty shall not apply, however, to the product that have been subjected to misuse, alteration, accident or negligence during handling or storage.

DISCLAIMER OF IMPLIED WARRANTIES:

All implied warranties, which may arise by implication of law or application of course of dealing or usage of trade, including, but not limited to, implied warranties of merchantability or fitness for a particular purpose are expressly excluded. There are no warranties, which extend beyond the description of the faced hereof. The end user is solely responsible for the suitability and fitness of this product selected for a particular application.

OBLIGATIONS

You warrant, represent and agree: (1) to comply with all laws; (2) that our sale and shipment of the product will not, by export thereof, your legal status or otherwise, cause us to violate any law; and (3) to indemnify us against any losses from a failure by you or a third party to comply with law or these terms and conditions, or from use of the product.

SAFETY WARNING

Failure or improper selection or improper use of the components and products described herein or related items can cause death, personal injury and/or property damage. This document and other related information from STC provide products options for further investigation by users having the technical expertise. It is important that you analyze all aspects of your application and review the information concerning the component or product in the current catalog. Due to the variety of operation conditions and applications for these components or products, the user, through his own analysis and testing, is solely responsible for making the final selection, installation and maintenance of the products and assuring that all performance, safety and warning requirements of the application are met. All products set-ups and maintenance require the supervision of a qualified individual who is familiar with installation, inspection and testing through training or experience.

IMPORTANT NOTICE:

The products described herein, including without limitation, product features, specifications, design, availability and pricing, are subject to change without notice. We continuously improve the products, and we reserve the right to change specifications without incurring any obligation to incorporate new factors in equipment previously sold.



Sizto Tech Corporation

892 Commercial Street
Palo Alto, CA 94303 USA

Tel: 650-856 8833 | Fax: 650-856 8811

Email: Sales@StcValve.com; www.StcValve.com