

X = Number of Stations

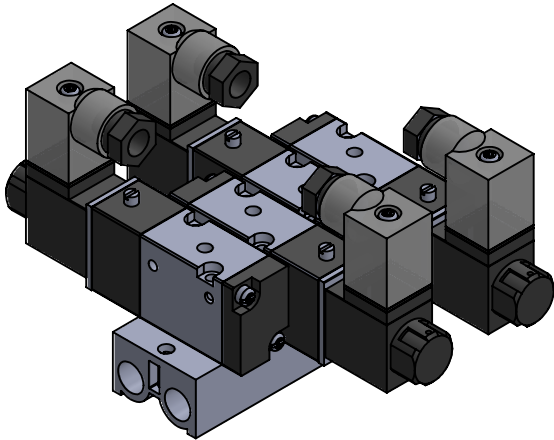

N.T.S.

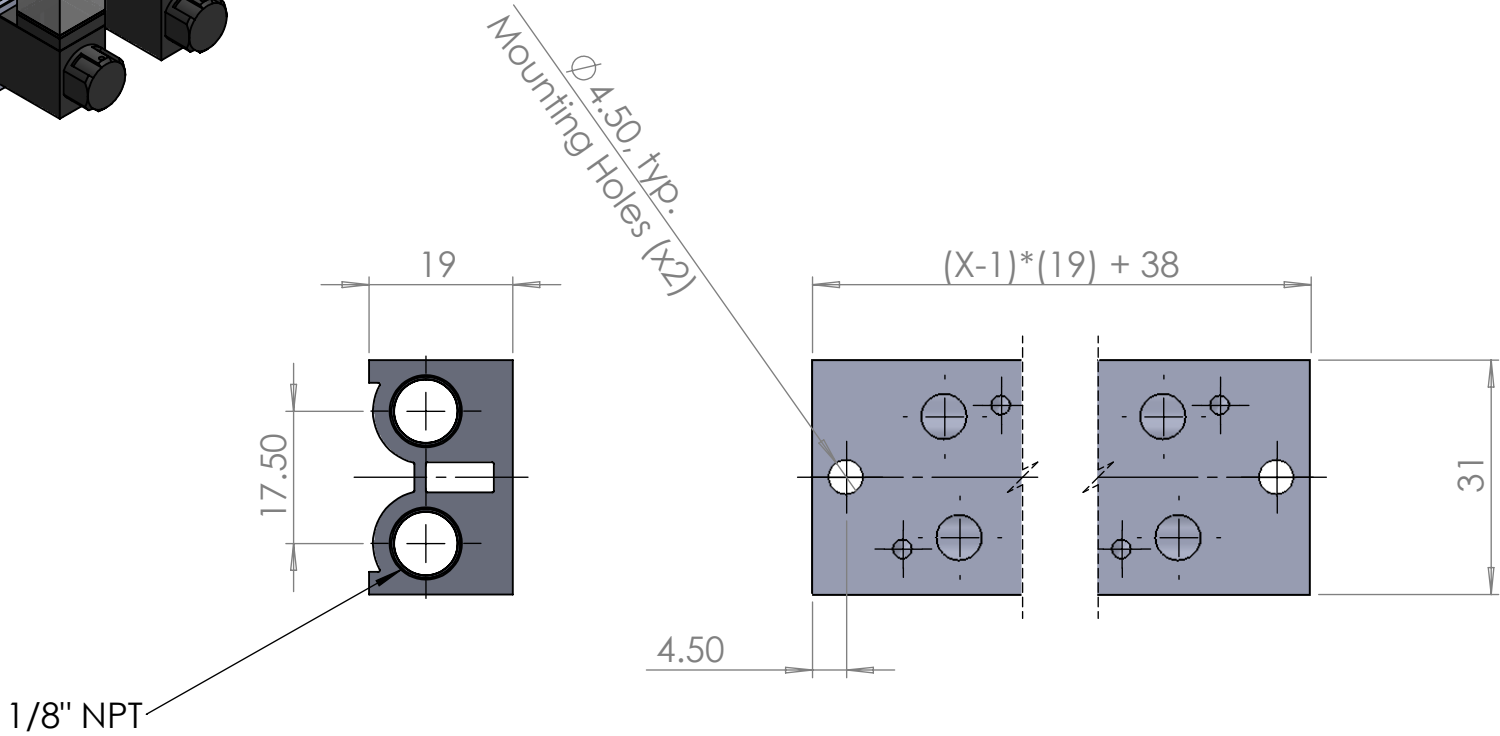

Part Number:

3V-100M-[X]

Manifold for 3V100 Series Solenoid Valves

11x8.5

kfi