











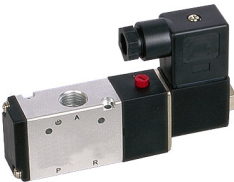



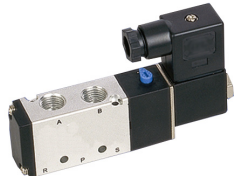
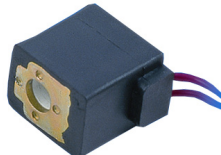

STC Solenoid & Air Pilot Valves

Solenoid & Air Pilot Valves

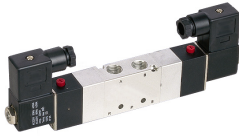
					
	<p>Precision Engineered</p> <p>Fine Quality</p>  <p>Advanced Design</p> <p>Excellent Prices</p>				
					
					



connects fluid power to industrial automation™

Table of Contents

STC Solenoid Valve Numbering System.....	C2
Solenoid Valve List Price.....	C3
Coil List Price.....	C3
Air Pilot Valve List Price.....	C4
Integrated Aluminum Base Mounted Manifolds.....	C4
Solenoid Valve and Air Pilot Valve Specifications.....	C4
Solenoid and Air Pilot Valves, and Manifolds Dimensions.....	C5-8

STC Solenoid Valve Numbering System

Ordering Part No. = (eg. 4V110-06-1-D)

4V

1

10

06

1

D

Model	Valve Size	Solenoid/Position	Port Size (NPT)	Voltage	Elec. Terminal	
3A = 3 way air pilot valve	1 = 0.67 Cv	10 = 1 solenoid 2 position	05 = 10-32	Blank = Standard	1 = 12 VDC	D = DIN
3V = 3 way solenoid valve	2 = 0.89 Cv	20 = 2 solenoid 2 position	06 = 1/8	B = Namur Mounting/ Actuator Mounting	2 = 24 VDC	G = Grommet
4A = 4 way air pilot valve	3 = 1.68 Cv	30 = 2 solenoid 3 position	10 = 3/8		2A = 24 VAC	E = Explosion Proof
4V = 4 way solenoid valve	4 = 2.78 Cv		15 = 1/2		3 = 110 VAC 4 = 220VAC	

STC Valve Manifold Numbering System*

Ordering Part No. = (eg. 4V100M-2)

4V100M

2

or

B

Model	No. of Stations	Blank Plate
3V100M = Manifold for 3V100 series valves	2	B = Blank plate G = Gasket and mounting hardware
3V200M = Manifold for 3V200 series valves	4	
3V300M = Manifold for 3V300 series valves	6	
3V400M = Manifold for 3V400 series valves	8	
4V100M = Manifold for 4V100 series valves	16	
4V200M = Manifold for 4V200 series valves		
4V300M = Manifold for 4V300 series valves		
4V400M = Manifold for 4V400 series valves		

* gasket and mounting hardware included

STC Solenoid Valve List Price



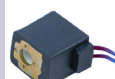

To Order, Please Specify: 1. Model No. 2. Voltage 3. Electrical Entry Options

	Part No.	Price	Voltage & Electrical Connection Options B. Electrical Connection	Port Size (NPT)	# Way/Port/Position/ Solenoid	Cv	Power	
	2V025-1/8	\$18.81	A. Voltage Options: 1 = 12 VDC 2 = 24VDC 2A=24VAC 3 = 110VAC 4 = 220VAC B. Terminal Options: D = DIN (with LED indicator & Conduit Terminal) G = Grommet (12" Lead Wire) E = Explosion Proof	1/8	2/2/2/1 Direct Acting	0.23	3W to 6.5 W	
	2V025-1/4	\$18.81		1/4				
	2V035-1/8	\$18.81		1/8	3/2/2/1 Direct Acting	0.1		
	2V035-1/4	\$18.81		1/4				
	2P025-1/8	\$18.43		1/8	2/2/2/1 Direct Acting	0.23		
	2P025-1/4	\$18.43		1/4				
	2P035-1/8	\$18.43		1/8	3/2/2/1 Direct Acting	0.1		
	2P035-1/4	\$18.43		1/4				
	2V1-1/8	\$18.81		1/8	2/2/2/1 Direct Acting	0.23		
	3V1-1/8	\$18.81		1/8	3/2/2/1 Direct Acting	0.1		
	3V110-1/8	\$24.26		1/8	3/3/2/1	0.67		2.5 W
	3V210-1/4	\$24.26		1/4, 1/8 (Exh)		0.89		3 W
	3V310-3/8	\$32.67		3/8, 1/4 (Exh)		1.68		3 W
	3V410-1/2	\$56.93		1/2		2.79		3 W
	3V120-1/8	\$37.16		1/8	3/3/2/2	0.67		2.5 W
	3V220-1/4	\$37.16		1/4, 1/8 (Exh)		0.89		3 W
	3V320-3/8	\$45.54		3/8, 1/4 (Exh)		1.68		3 W
	3V420-1/2	\$79.70		1/2		2.79		3 W
	4V110-1/8	\$25.25		1/8	4/5/2/1	0.67		2.5 W
	4V210-1/4	\$24.26		1/4, 1/8 (Exh)		0.89		3 W
	4V310-3/8	\$32.67	3/8, 1/4 (Exh)	1.68		3 W		
	4V410-1/2	\$56.93	1/2	2.79		3 W		
	3V310B-1/4	\$37.62	1/4	3/3/2/1	1.68	3 W		
	4V310B-1/4	\$37.62	1/4	4/5/2/1	1.68	3 W		
	4V310B-3/8	\$37.62	3/8, 1/4 (Exh)		1.68	3 W		
	4V120-1/8	\$37.13	1/8	4/5/2/2	0.67	2.5 W		
	4V220-1/4	\$37.13	1/4, 1/8 (Exh)		0.89	3 W		
	4V320-3/8	\$45.54	3/8, 1/4 (Exh)		1.68	3 W		
	4V420-1/2	\$79.70	1/2		2.79	3 W		
	4V130C-1/8	\$64.35	1/8	4/5/3/2 Closed Center	0.5	2.5 W		
	4V230C-1/4	\$64.35	1/4, 1/8 (Exh)		0.67	3 W		
	4V330C-3/8	\$88.61	3/8, 1/4 (Exh)		1	3 W		
	4V430C-1/2	\$113.85	1/2	1.68	3 W			
	4V130P-1/8	\$64.35	1/8	4/5/3/2 Pressure Center	0.5	2.5 W		
	4V230P-1/4	\$64.35	1/4, 1/8 (Exh)		0.67	3 W		
	4V330P-3/8	\$88.61	3/8, 1/4 (Exh)		1	3 W		
	4V430P-1/2	\$113.85	1/2	1.68	3 W			
	4V130E-1/8	\$64.35	1/8	4/5/3/2 Exhaust Center	0.5	2.5 W		
	4V230E-1/4	\$64.35	1/4, 1/8 (Exh)		0.67	3 W		
4V330E-3/8	\$88.61	3/8, 1/4 (Exh)	1		3 W			
4V430E-1/2	\$113.85	1/2	1.68	3 W				

	Part No.	Price	Voltage Options	Electrical Connection Options	Power Consumption	Specifications	To connect DIN coil: 1. Remove the Philip screw from the plastic housing and unplug it from the DIN coil. 2. From the screw opening, use the screw to push the terminal block out of the plastic housing. 3. Note the 1, 2 and ground markings on underside of DIN enclosure. 4. For DC DIN Coil, Connect 1 to Positive, 2 to Negative. 5. For AC DIN Coil, connect 1 to HOT wire, 2 to Neutral wire, and if required connect ground to ground wire. To connect Grommet coil: 1. For DC Coil, connect one of the two wires to Positive, and the other wire to Negative. 2. For AC Coil, connect one of the two wires to HOT wire,
	100C	\$7.92	Voltage Options: 1 = 12 VDC 2 = 24VDC 2A=24VAC 3 = 110VAC 4 = 220VAC	D = DIN (with LED indicator, conduit terminal)	2.5 W	Insulation: F Class IP65; Duty Cycle: 100% ED; CE Certification	
	200C	\$7.92		G = Grommet (12" Lead Wire)	3W		
	100C	\$7.13		G = Grommet (12" Lead Wire)	2.5 W		
	200C	\$7.13		G = Grommet (12" Lead Wire)	3 W		





Air Pilot Valve List Price

	Part No.	Price	Port Size (NPT)	# Ways/Port/ Position/Pilot	Cv		Part No.	Price	Port Size (NPT)	# Ways/Port/ Position/Pilot	Cv
	3A110-1/8	\$18.81	1/8	3/3/2/1	0.67		4A130C-1/8	\$49.01	1/8	4/5/3/2 Closed Center	0.5
	3A210-1/4	\$18.81	1/4, 1/8 (Exh)		0.89		4A230C-1/4	\$49.01	1/4, 1/8 (Exh)		0.67
	3A310-3/8	\$22.77	3/8, 1/4 (Exh)		1.68		4A330C-3/8	\$71.78	3/8, 1/4 (Exh)		1
	3A410-1/2	\$37.62	1/2		2.79		4A430C-1/2	\$85.36	1/2		1.68
	3A120-1/8	\$23.76	1/8	3/3/2/2	0.67		4A130P-1/8	\$49.01	1/8	4/5/3/2 Pressure Center	0.5
	3A220-1/4	\$24.26	1/4, 1/8 (Exh)		0.89		4A230P-1/4	\$49.01	1/4, 1/8 (Exh)		0.67
	3A320-3/8	\$28.71	3/8, 1/4 (Exh)		1.68		4A330P-3/8	\$71.78	3/8, 1/4 (Exh)		1
	3A420-1/2	\$49.01	1/2		2.79		4A430P-1/2	\$85.36	1/2		1.68
	4A110-1/8	\$18.81	1/8	4/5/2/1	0.67		4A130E-1/8	\$49.01	1/8	4/5/3/2 Exhaust Center	0.5
	4A210-1/4	\$18.81	1/4, 1/8 (Exh)		0.89		4A230E-1/4	\$49.01	1/4, 1/8 (Exh)		0.67
	4A310-3/8	\$22.77	3/8, 1/4 (Exh)		1.68		4A330E-3/8	\$71.78	3/8, 1/4 (Exh)		1
	4A410-1/2	\$37.62	1/2		2.79		4A430E-1/2	\$85.36	1/2		1.68
	4A120-1/8	\$23.76	1/8	4/5/2/2	0.67						
	4A220-1/4	\$24.26	1/4, 1/8 (Exh)		0.89						
	4A320-3/8	\$28.71	3/8, 1/4 (Exh)		1.68						
	4A420-1/2	\$49.01	1/2		2.79						

Integrated Aluminum Base Mounted Manifolds*

To Order, Please Specify: 1. Model No. 2. Voltage 3. Electrical Entry Options

	Part No.	Number of Stations	Description		Part No.	Number of Stations	Description
	3V-100M-2	\$11.00/2 stations	Integrated Base for Mounting 3V100 or 3A100 series Solenoid Valves		4V-100M-2	\$11.00/2 station	Integrated Base for Mounting 4V100 or 4A100 series Solenoid Valves
	3V-100M-4	\$22.00/4 stations			4V-100M-4	\$22.00/4 station	
	3V-100M-6	\$33.00/6 stations			4V-100M-6	\$33.00/6 station	
	3V-100M-8	\$44.00/8 stations			4V-100M-8	\$44.00/8 stations	
	3V-100M-16	\$88.00/16 stations			4V-100M-16	\$88.00/16 stations	
	3V-100M-B	\$4.84/blank plate			4V-100M-B	\$4.84/blank plate	
	3V-200M-2	\$11.00/2 stations	Integrated Base for Mounting 3V200 or 3A200 series Solenoid Valves		4V-200M-2	\$11.00/2 stations	Integrated Base for Mounting 4V200 or 4A200 series Solenoid Valves
	3V-200M-4	\$22.00/4 stations			4V-200M-4	\$22.00/4 stations	
	3V-200M-6	\$33.00/6 stations			4V-200M-6	\$33.00/6 stations	
	3V-200M-8	\$44.00/8 stations			4V-200M-8	\$44.00/8 stations	
	3V-200M-16	\$88.00/16 stations			4V-200M-16	\$88.00/16 stations	
	3V-200M-B	\$4.84/blank plate			4V-200M-B	\$4.84/blank plate	
3V-300M-2	\$16.50/2 stations	Integrated Base for Mounting 3V300 or 3A300 series Solenoid Valves	4V-300M-2	\$16.50/2 stations	Integrated Base for Mounting 4V300 or 4A300 series Solenoid Valves		
3V-300M-4	\$33.00/4 stations		4V-300M-4	\$33.00/4 stations			
3V-300M-6	\$49.50/6 stations		4V-300M-6	\$49.50/6 stations			
3V-300M-8	\$66.00/8 stations		4V-300M-8	\$66.00/8 stations			
3V-300M-16	\$132.00/16 stations		4V-300M-16	\$132.00/16 stations			
3V-300M-B	\$4.84/blank plate		4V-300M-B	\$4.84/blank plate			
3V-400M-2	\$27.50/2 stations	Integrated Base for Mounting 3V400 or 3A400 series Solenoid Valves	4V-400M-2	\$27.50/2 stations	Integrated Base for Mounting 4V400 or 4A400 series Solenoid Valves		
3V-400M-4	\$55.00/4 stations		4V-400M-4	\$55.00/4 stations			
3V-400M-6	\$82.50/6 stations		4V-400M-6	\$82.50/6 stations			
3V-400M-8	\$110.00/8 stations		4V-400M-8	\$110.00/8 stations			
3V-400M-16	\$220.00/16 stations		4V-400M-16	\$220.00/16 stations			
3V-400M-B	\$4.84/blank plate		4V-400M-B	\$4.84/blank plate			

* Includes mounting hardware and seals

Specifications

Valve Type	3V & 4V 100-400 Series Valves	2V1, 3V1, 2V025-035 2P025-035 Series Valves	3A & 4A 100-400 Series Valves
Port & Mounting	Body Ported, Manifold Mounted	Body Ported, Stacking or Manifold Mounted	Body Ported, Manifold Mounted
Action & Motion	Internal Pilot, Spool Design	Direct Acting	Air Pilot, Spool Design
Operating Pressure	21 to 115 PSI	Vacuum to 115 PSI	0 to 115 PSI
Coil Insulation & Protection Class	F Class, IP65 (CE Certification)	F Class, IP65 (CE Certification)	N/A
Coil Duty Cycle	100% ED	100% ED	100% ED
Manual Override	Non-Locking: 100 series,	Non-Locking	N/A
Electrical Connection	D = DIN (with LED indicator, conduit terminal)		N/A
Working Medium	40 micron filtered air or inert gas	40 micron filtered air, inert gas & liquid	40 micron filtered air or inert gas
Maximum Pressure	180 PSI		
Operating Temperature	14 to 140 Deg. F (-10 to 60 Deg. C)		
Body Material	Aluminum (Engineered Plastic for 2P Series)		
Seal Material	NBR (Buna N)		
Lubrication	Not Required		



Solenoid Valve Dimensions

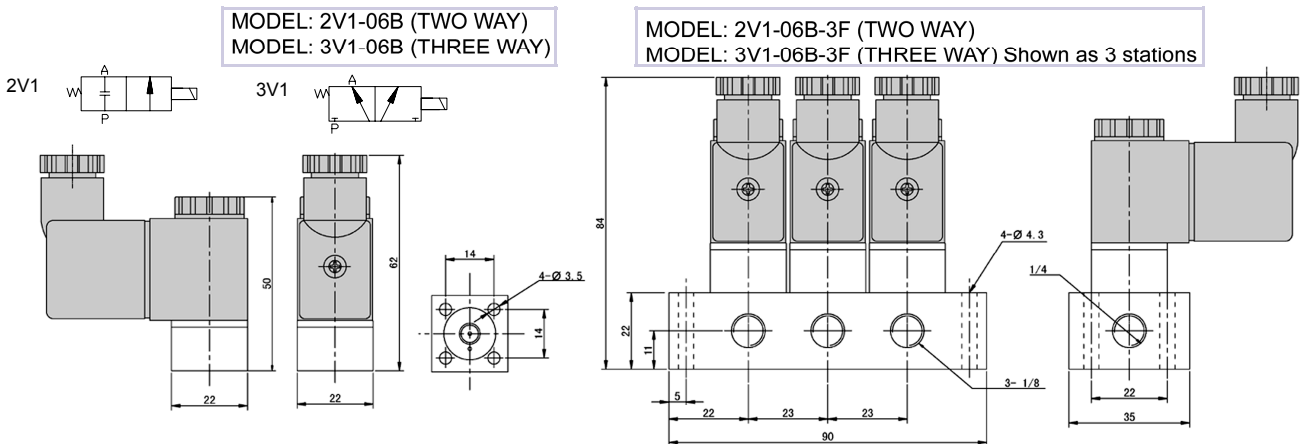
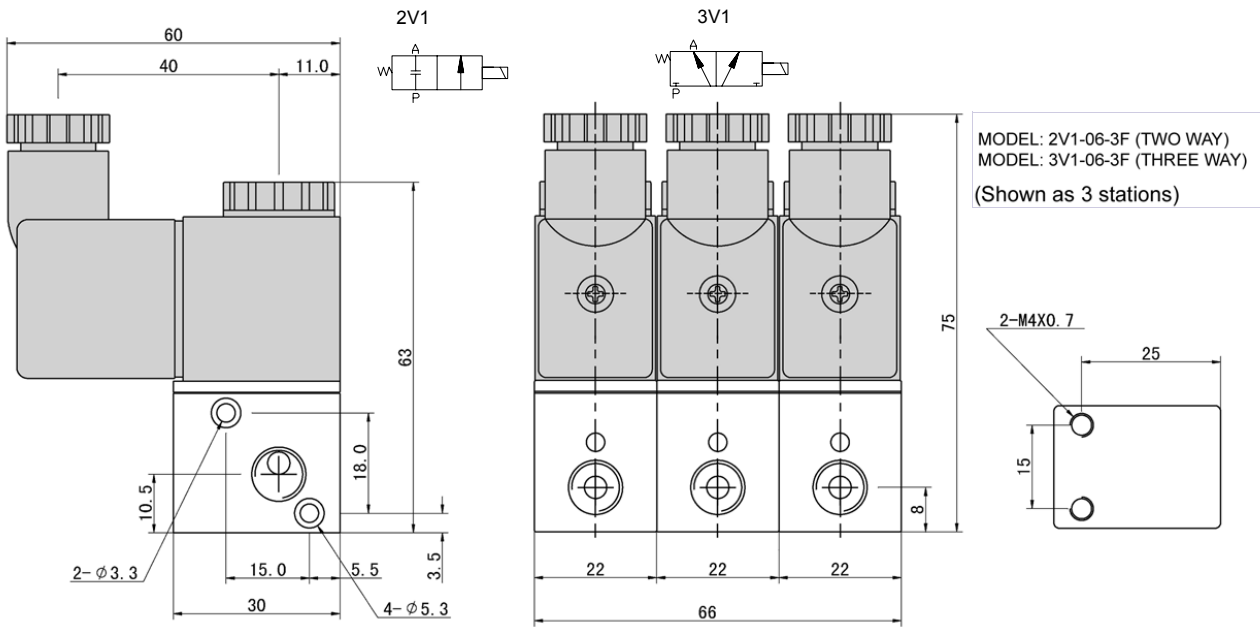
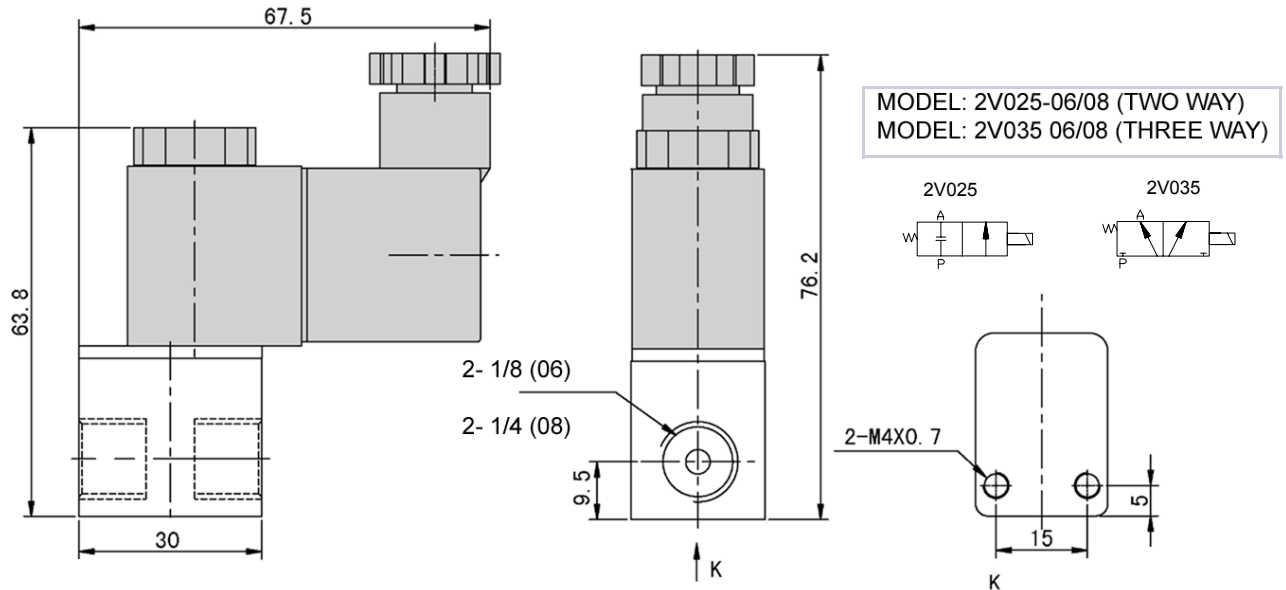

Solenoid & Air Pilot Valves Dimensions

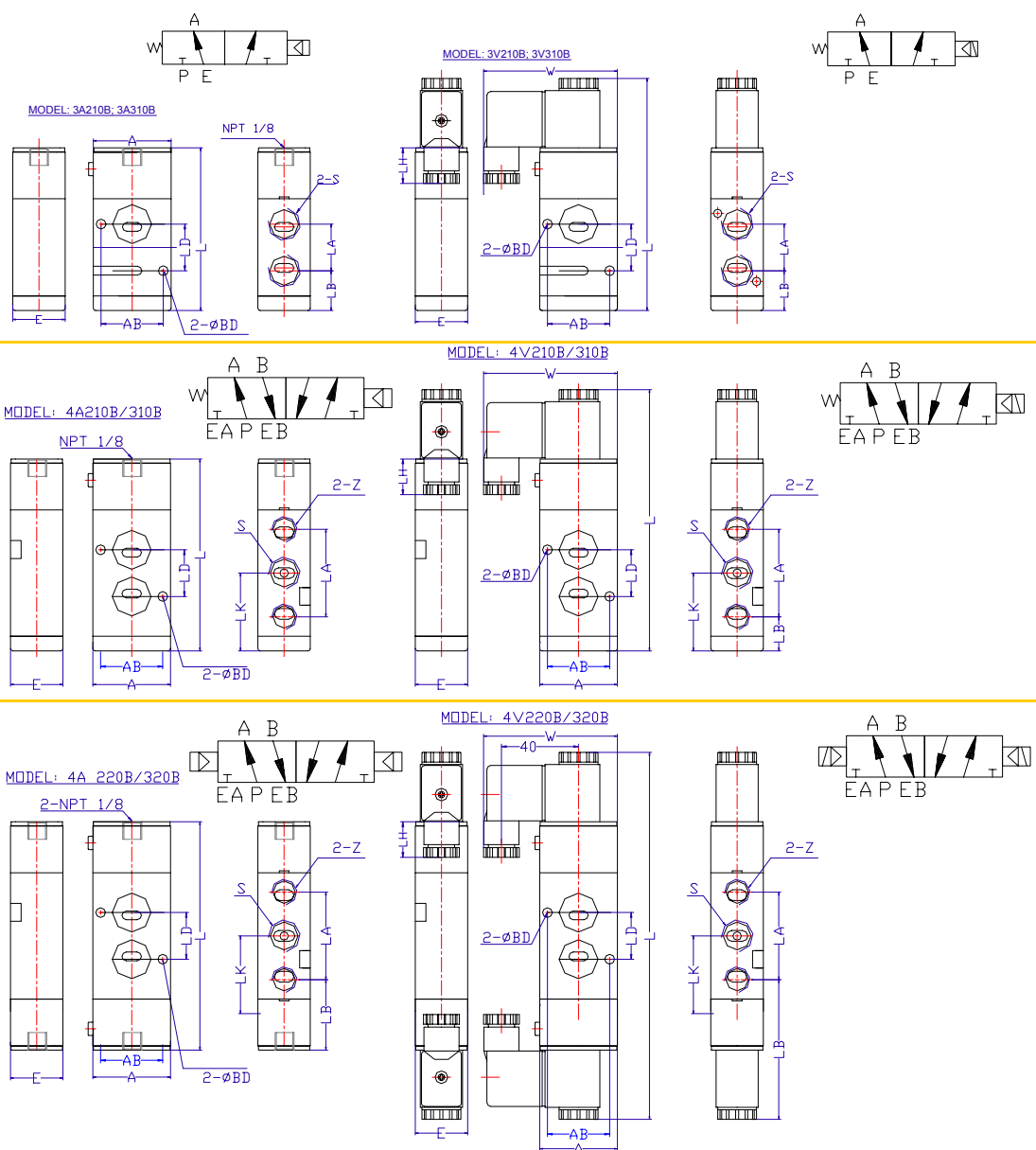

MODEL	A	E	L	S	W	Z	AB	BD	LA	LB	LD	LH	LK
3A210-1/4B	35	22	77.7	1/4	66.5		29	4.3	18	21			
3A310-1/4B	40	27	80.5	3/8	69		32	5.5	24	20.5			
3A310-3/8B	40	27	80.5	3/8	69		32	5.5	24	20.5			
3V210-1/4B	35	22	111.5	1/4	66.5		29	4.3	18	21		18	
3V310-1/4B	40	27	119.4	1/4	69		32	5.5	24	20.5		18	
3V310-3/8B	40	27	119.4	3/8	69		32	5.5	24	20.5		18	
4A210-1/4B	35	22	77.7	1/4	66.5	1/8	29	4.3	36	13.5	23		31.7
4A310-1/4B	40	27	95.5	1/4	69	1/4	32	5.5	45	17.5	24		40
4A310-3/8B	40	27	95.5	3/8	69	1/4	32	5.5	45	17.5	24		40
4V210-1/4B	35	22	116.5	1/4	66.5	1/8	29	4.3	36	13.5	23	18	32.5
4V310-1/4B	40	27	134.5	1/4	69	1/4	32	5.5	45	17.5	24	18	40
4V310-3/8B	40	27	134.5	3/8	69	1/4	32	5.5	45	17.5	24	18	40
4A220-1/4B	35	22	92	1/4	66.5	1/8	29	4.3	36	28	23		46
4A320-1/4B	40	27	111	1/4	69	1/4	32	5.5	45	33	24		55.5
4A320-3/8B	40	27	111	3/8	69	1/4	32	5.5	45	33	24		55.5
4V220-1/4B	35	22	169.8	1/4	66.5	1/8	29	4.3	36	66.9	23	18	84.9
4V320-1/4B	40	27	188.8	1/4	69	1/4	32	5.5	45	71.9	24	18	94.4
4V320-3/8B	40	27	188.8	3/8	69	1/4	32	5.5	45	71.9	24	18	94.4



Solenoid & Air Pilot Valves Dimensions

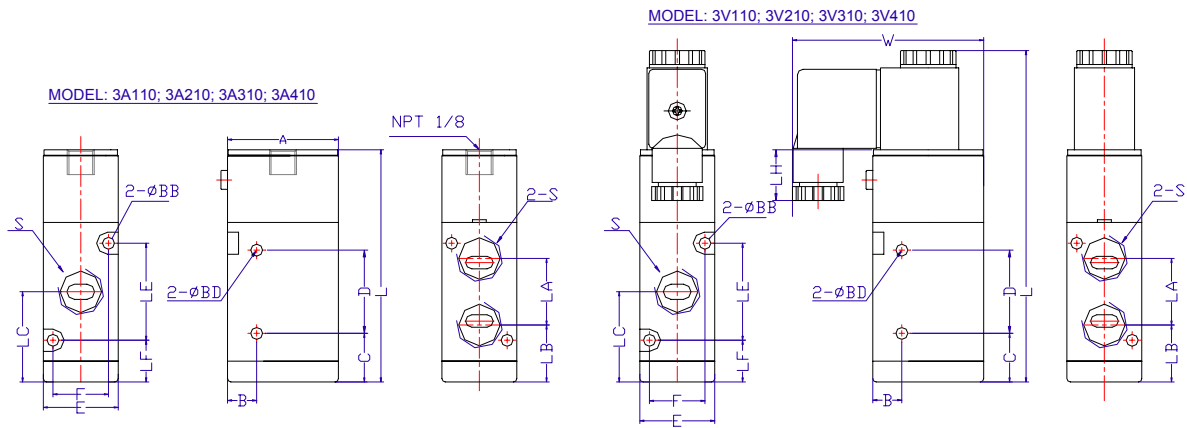
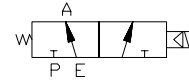
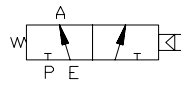

MODEL	A	B	D	E	F	L	S	W	BB	BD	LA	LB	LC	LE	LF	LH
3A110-1/8	27	7.7	21	18.0	13	56.5	1/8	53.5	3.3	3.3	16	14.0	23	19	12.5	
3A210-1/4	35	8.0	25	22.0	17	77.7	1/4	66.5	3.3	4.3	18	21.0	31	33	12.5	
3A310-3/8	40	10.5	30	27.0	20	80.5	3/8	69	4.3	4.3	24	20.5	32.5	35	15	
3A410-1/2	50	13.5	51	34.0	27	96.5	1/2	73.9	4.3	5.5	36	25.5	41.5	44	15.5	
3V110-1/8	27	7.7	21	18.0	13	85.8	1/8	53.5	3.3	3.3	16	14.0	23	19	12.5	10
3V210-1/4	35	8.0	25	22.0	17	111.5	1/4	66.5	3.3	4.3	18	21.0	31	33	12.5	18
3V310-3/8	40	10.5	30	27.0	20	119.4	3/8	69	4.3	4.3	24	20.5	32.5	35	15	18
3V410-1/2	50	13.5	51	34.0	27	137.0	1/2	73.5	4.3	5.5	36	25.5	41.5	44	15.5	18

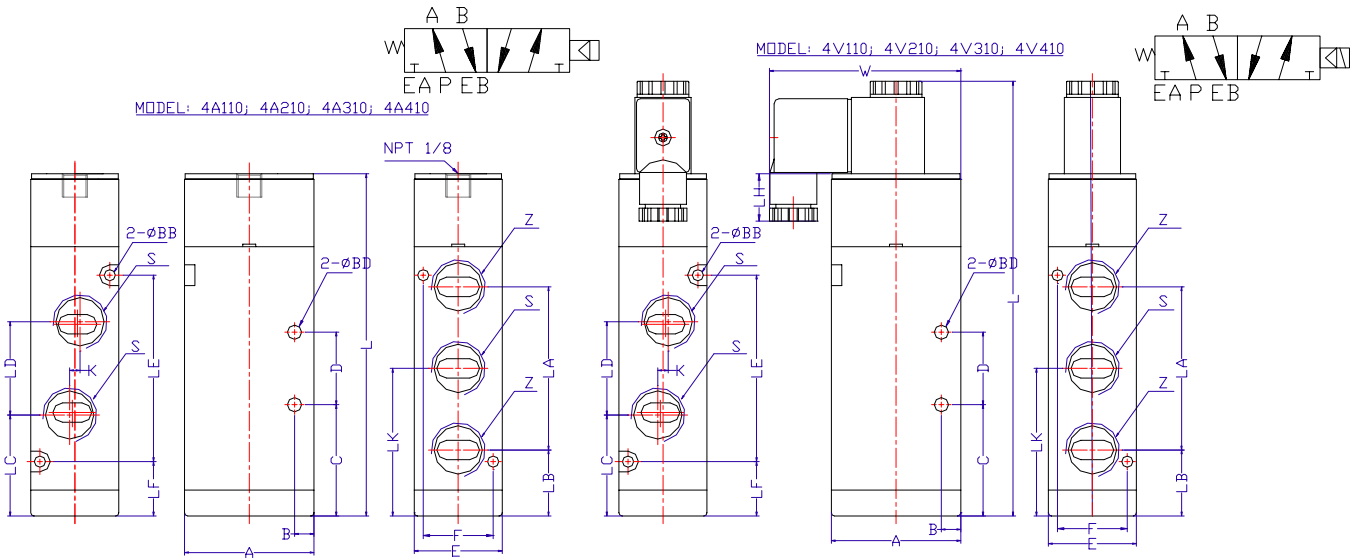

MODEL	A	B	C	D	E	F	K	L	S	W	Z	BB	BD	LA	LB	LC	LD	LE	LF	LH	LK
4A110-1/8	27	4.0	21.0	14	18	13	3	68.7	1/8	53.5	1/8	3.3	3.3	28	14.2	20.2	16	30	13.0		28.2
4A210-1/4	35	7.0	21.5	20	22	17	3	77.7	1/4	66.5	1/8	3.3	4.3	36	13.5	21.0	21	38	12.5		31.7
4A310-3/8	40	6.5	28.0	24	27	20	4	95.5	3/8	69	1/4	4.3	4.3	45	17.5	28.0	24	50	15.0		40.0
4A410-1/2	50	7.5	43.0	28	34	27	4	128	1/2	73.5	1/2	4.3	5.5	63	25.5	39.0	36	72	21.0		57.0
4V110-1/8	27	4.0	21.0	14	18	13	3	98	1/8	53.5	1/8	3.3	3.3	28	14.0	20.0	16	30	13.0	10	28.0
4V210-1/4	35	7.0	21.5	20	22	17	3	116.5	1/4	66.5	1/8	3.3	4.3	36	13.5	21.0	21	38	12.5	18	32.5
4V310-3/8	40	6.5	28.0	24	27	20	4	134.5	3/8	69	1/4	4.3	4.3	45	17.5	28.0	24	50	15.0	18	40.0
4V410-1/2	50	7.5	43.0	28	34	27	4	167.9	1/2	73.5	1/2	4.3	5.5	63	25.5	39.0	36	72	21.0	18	57.0

Solenoid & Air Pilot Valves & Manifolds Dimensions

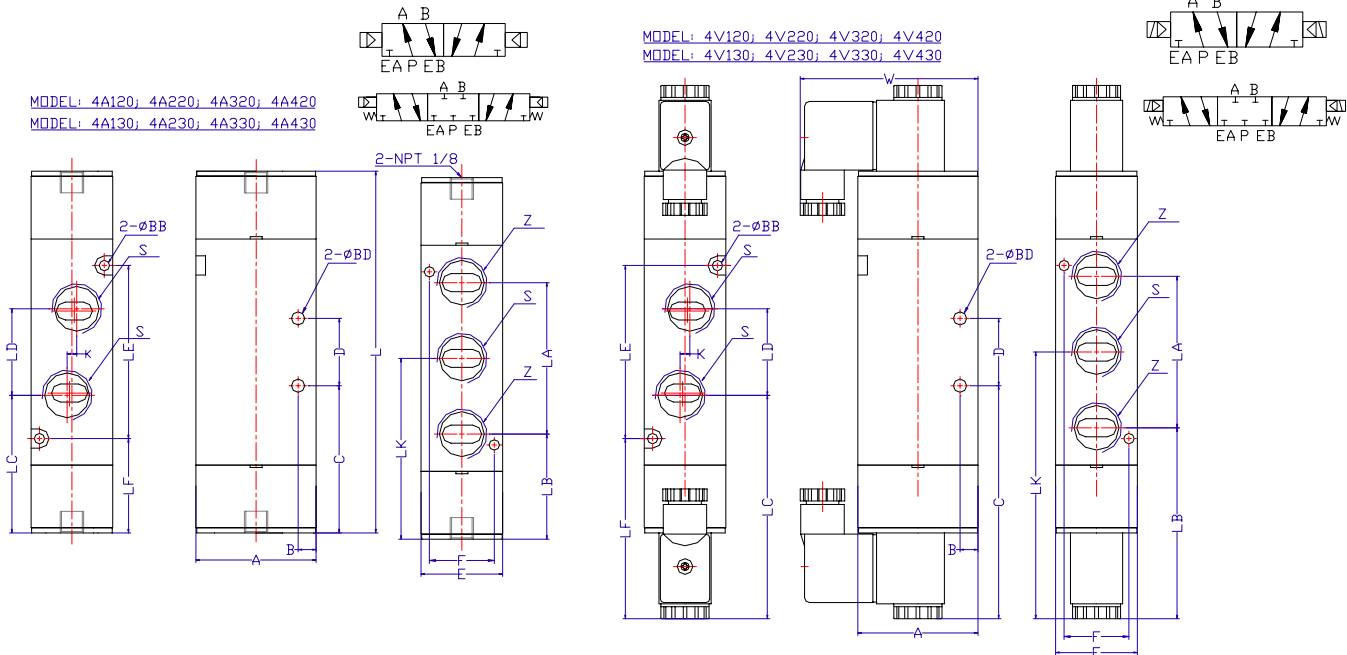

MODEL	A	B	C	D	E	F	K	L	S	W	Z	BB	BD	LA	LB	LC	LD	LE	LF	LH	LK
4A120-1/8	27	4.0	33.5	14	18	13	3	81	1/8	53.5	1/8	3.3	3.3	28	26.5	32.5	16	30	25.5		40.5
4A220-1/4	35	7.0	36.0	20	22	17	3	92	1/4	66.5	1/8	3.3	4.3	36	28.0	37.0	21	38	27.0		46.0
4A320-3/8	40	6.5	43.5	24	27	20	4	111	3/8	69	1/4	4.3	4.3	45	33.0	43.5	24	50	30.5		55.5
4A420-1/2	50	7.5	51.0	28	34	27	4	128	1/2	73.5	1/2	4.3	5.5	63	39.5	71.0	36	72	35.0		71.0
4V120-1/8	27	4.0	62.8	14	18	13	3	139.5	1/8	53.5	1/8	3.3	3.3	28	56.0	52.0	16	30	54.8	10	69.8
4V220-1/4	35	7.0	74.9	20	22	17	3	169.8	1/4	66.5	1/8	3.3	4.3	36	66.9	74.4	21	38	65.9	18	84.9
4V320-3/8	40	6.5	82.4	24	27	20	4	188.8	3/8	69	1/4	4.3	4.3	45	71.9	82.4	24	50	69.4	18	94.4
4V420-1/2	50	7.5	96.9	28	34	27	4	217.5	1/2	73.5	1/2	4.3	5.5	63	79.4	92.9	36	72	74.9	18	110.9
4A130-1/8	27	4.0	33.5	14	18	13	3	96	1/8	53.5	1/8	3.3	3.3	28	26.5	32.5	16	30	25.5		40.5
4A230-1/4	35	7.0	36.0	20	22	17	3	110	1/4	66.5	1/8	3.3	4.3	36	28.0	37.0	21	38	27.0		46.0
4A330-3/8	40	6.5	43.5	24	27	20	4	130	3/8	69	1/4	4.3	4.3	45	33.0	43.5	24	50	30.5		55.5
4A430-1/2	50	7.5	51.0	28	34	27	4	165	1/2	73.5	1/2	4.3	5.5	63	39.5	71.0	36	72	35.0		71.0
4V130-1/8	27	4.0	62.8	14	18	13	3	154.6	1/8	53.5	1/8	3.3	3.3	28	56.0	52.0	16	30	54.8	10	69.8
4V230-1/4	35	7.0	74.9	20	22	17	3	188.8	1/4	66.5	1/8	3.3	4.3	36	66.9	74.4	21	38	65.9	18	84.9
4V330-3/8	40	6.5	82.4	24	27	20	4	207.8	3/8	69	1/4	4.3	4.3	45	71.9	82.4	24	50	69.4	18	94.4
4V430-1/2	50	7.5	96.9	28	34	27	4	242.8	1/2	73.5	1/2	4.3	5.5	63	79.4	92.9	36	72	74.9	18	110.9

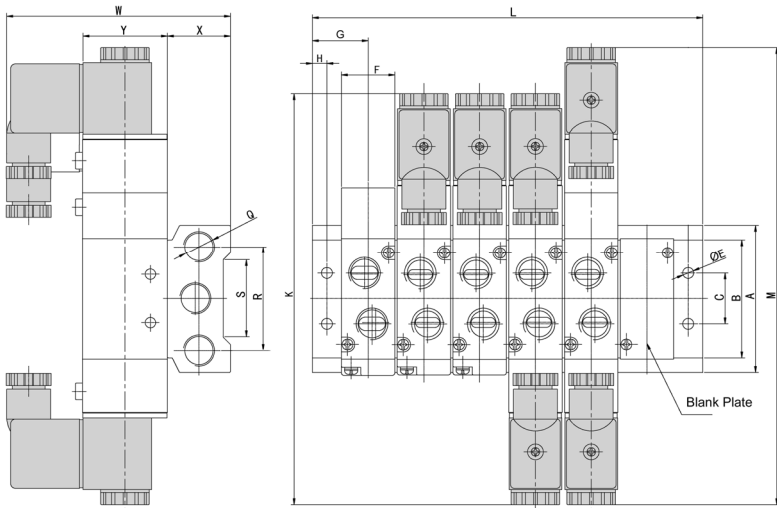

4V100-400M Manifold Dimensions

MODEL	A	B	C	E	F	G	H	K	L
100M	58	44	20	4.2	18.3	19	5	140	(N-1)*19+38
200M	61	51	21	4.3	22.4	23	6	170	(N-1)*23+46
300M	75	65	26	4.5	27.3	27	6	189	(N-1)*28+54
400M	104	95	32	5.5	34.3	31.5	7	222	(N-1)*35+63

MODEL	M	Q	R	S	T	W	X	Y
100M	155	1/4	40	30	M3x.5	78.5	25	27
200M	189	1/4	43	32	M3x.5	92.5	26	35
300M	208	3/8	53	48	M4x.7	99	30	40
400M	243	1/2	68	67	M4x.7	112	38	50



STC

Manual & Actuated Process Valves



Table of Contents

STC Process Valve Numbering System.....D2

STC Solenoid Valve List Price.....D3

Electrical Coil List Price.....D4

STC Solenoid Valve Specifications.....D4

STC Valve List Price.....D4

STC Valve Technical Data.....D5-8

STC Process Valve Numbering System

Ordering Part No. =
eg. 2W025-1/4-1-G



NC (Normally Closed) NO (Normally Open)	Model	BODY SIZE	PORT SIZE (NPT)	VOLTAGE	ELEC. CONNECTION
NC Brass High Pressure	2L	025	1/8	1 = 12 VDC 2 = 24 VDC 2A = 24 VAC 3 = 110 VAC 4 = 220VAC	BLANK = Standard DIN Con- nection (with Conduit Terminal) G = Grommet Terminal (Options for 2P and 2V series valves)
NC Engineered Plastic	2P	025	1/4		
NC Anodized Aluminum	2V	040	3/8		
NC 304 Stainless Steel	2S	160	3/8		
NO 304 Stainless Steel	2SO	160	1/2		
NC Brass	2W	200	3/4		
NO Brass	2WO	250	1		
NC Brass	VX	350	1 1/4		
NC Anodized Aluminum	VXF	400	1 1/2		
AIR PILOT VALVES		500	2		
NC Brass	QW				
NO Brass Air Pilot	QWO				

Ordering Part No. =
eg. 2W200C-1

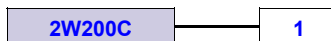

COILS	MODEL	VOLTAGE
Coil for 2W & 2S 025 TO 250 series valves	2W200C	1 = 12 VDC
Coil for 2W & 2S 350 TO 500 series valves	2W300C	2 = 24 VDC
Coil for 2WO & 2SO 160 TO 500 series valves	2WOC	2A = 24 VAC
Coil for 2P & 2V Series Valves	200C	3 = 110 VAC
		4 = 220VAC

Ordering Part No. =
eg. V1-1/4

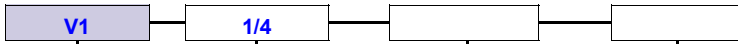

MANUAL BALL VALVES	MODEL	PORT SIZE (NPT)	Mounting	
Reduced port 316 SS ball valve (1 Piece)	V1	1/4	Blank = No mounting Option A=Actuator Mount P= Panel Mount	
Full port 316 SS ball valve (2 Piece)	V2	3/8		
Full port 316 SS ball valve (3 Piece)	V3	1/2		
Full port 316 SS ball valve (3 Piece, Tri-Clamp)	V3C	3/4		
Full port brass ball valve (2 Piece)	T101L	1		
Reduced port chrome plated brass ball valve (FXF port)	T400	1 1/4		
Reduced port chrome plated brass ball valve (FXM port)	T400FM	1 1/2		
316 SS Needle valve	VNO1	2		
VALVE ACTUATORS	MODEL	Actuator Bore Size (mm)	Rotation	Action
ROTARY PNEUMATIC VALVE ACTUATORS	KT	45	90 180	S=Single Acting (Spring Return) D=Double Acting (Air Return)
		63		
		83		
		105		
		140		
		160		
		210		
280				



STC Solenoid Valve List Price

To Order, Please Specify: 1. Model No. 2. Voltage

	Part No.	List Price	Port Size (NPT)	Cv	Voltage	Features		
	2P025-1/8	\$18.43	1/8	0.23	Voltage Options: 1 = 12 VDC 2 = 24VDC 2A=24VAC 3 = 110VAC 4 = 220VAC	2 Way, Direct Acting, Normally Closed Operating Temp: -5 to 80 deg. C Operating Pressure: Vacuum to 115 PSI Coil: F Class, IP65, 100% ED Service: Air, Gas, Liquid Seals: NBR, (Viton Option) Body Material: 2P Series: Engineered Plastic 2S Series: 304 Stainless Steel Body 2V Series: Anodized Aluminum Body 2W Series: Brass		
	2P025-1/4	\$18.43	1/4	0.23				
	2S025-1/4	\$30.69	1/4	0.23				
	2S040-3/8	\$42.57	3/8	0.6				
	2V025-1/8	\$18.81	1/8	0.23				
	2V025-1/4	\$18.81	1/4	0.23				
	2W025-1/4	\$27.50	1/4	0.23				
	2W040-3/8	\$34.16	3/8	0.6				
	2W160-3/8	\$54.45	3/8	4.8			Voltage Options: 1 = 12 VDC 2 = 24VDC 2A=24VAC 3 = 110VAC 4 = 220VAC	2 Way, Direct Acting/Lift, Normally Closed Operating Temp: -5 to 80 deg. C Operating Pressure: Vacuum to 115 PSI Coil: F Class, IP65, 100% ED Service: Air, Gas, Liquid Seals: NBR, (Viton Option) Body Material: Brass
	2W160-1/2	\$54.45	1/2	4.8				
	2W200-3/4	\$62.87	3/4	7.6				
	2W250-1	\$76.73	1	12				
	2W350-1 1/4	\$169.29	1 1/4	24				
	2W400-1 1/2	\$188.10	1 1/2	29				
	2W500-2	\$273.24	2	48				
	2S160-3/8	\$103.46	3/8	4.8	Voltage Options: 1 = 12 VDC 2 = 24VDC 2A=24VAC 3 = 110VAC 4 = 220VAC	2 Way, Direct Acting/Lift, Normally Closed Operating Temp: -5 to 80 deg. C Operating Pressure: Vacuum to 115 PSI Coil: F Class, IP65, 100% ED Service: Air, Gas, Liquid Seals: NBR, (Viton Option) Body Material: 304 Stainless Steel		
	2S160-1/2	\$103.46	1/2	4.8				
	2S200-3/4	\$117.32	3/4	7.6				
	2S250-1	\$131.18	1	12				
	2S350-1 1/4	\$239.71	1 1/4	24				
	2S400-1 1/2	\$255.75	1 1/2	29				
	2S500-2	\$399.56	2	48				
	QW-1/2	\$123.20	1/2	4.8	Pilot Pressure: 80-150 PSI	2 Way, Direct Acting, NC Operating Temp -5 to 80 deg. C Operating Pressure: 100 PSI Service: Air, Water, Oil, Gas Seals: Teflon Body Material: Brass		
	QW-3/4	\$132.00	3/4	7.6				
	QW-1	\$162.00	1	12				
	QW-1 1/2	\$266.37	1 1/2	29				
	QW-2	\$332.97	2	48				



STC Solenoid Valve List Price

To Order, Please Specify: 1. Model No. 2. Voltage

	Part No.	List Price	Port Size (NPT)	Cv	Voltage	Features		
	2WO 160-3/8	\$91.58	3/8	4.8	Voltage Options: 1 = 12 VDC 2 = 24VDC 2A=24VAC 3 = 110VAC 4 = 220VAC	Normally Open 2 Way, Direct Acting/Lift, Operating Temp: -5 to 80 deg. C Operating Pressure: Vacuum to 115 PSI Coil: F Class, IP65, 100% ED Service: Air, Liquid Seals: NBR (Option: Viton, EPDM) Body Material: 2S Series: 304 Stainless Steel 2W Series: Brass		
	2WO 160-1/2	\$91.58	1/2	4.8				
	2WO 200-3/4	\$99.88	3/4	7.6				
	2WO 250-1	\$116.55	1	12				
	2WO 350-1 1/4	\$183.10	1 1/4	24				
	2WO 400-1 1/2	\$203.42	1 1/2	29				
	2WO 500-2	\$295.50	2	48				
	2SO 160-3/8	\$119.00	3/8	4.8				
	2SO 160-1/2	\$129.84	1/2	4.8				
	2SO 200-3/4	\$151.51	3/8	7.6				
	2SO 250-1	\$238.00	1	12				
	2SO 350-1 1/4	\$335.41	1 1/4	24				
	2SO 400-1 1/2	\$372.69	1 1/2	29				
	2SO 500-2	\$541.37	2	48				
	2L170-3/8	\$87.95	3/8	4.8	Voltage Options: 1 = 12 VDC 2 = 24VDC 2A=24VAC 3 = 110VAC 4 = 220VAC	Normally Closed, 2 Way, Direct Acting Brass Body, Seals: PTFE Operating Temp: -5 to 150 deg. C Operating Pressure: 215 PSI Coil: F Class, IP65, 100% ED Service: Air, Liquid, Steam Installation: Vertical Coil Position		
	2L170-1/2	\$103.46	1/2	4.8				
	2L170-3/4	\$117.32	3/4	4.8				
	2L200-1	\$131.18	1	12				
	2L300-1 1/4	\$185.52	1 1/4	20				
	2L300-1 1/2	\$216.32	1 1/2	20				
	2L500-2	\$325.22	2	48				
	VX2120-1/8		1/8	0.33			Voltage Options: 1 = 12 VDC 2 = 24VDC 2A=24VAC 3 = 110VAC 4 = 220VAC	Normally Closed, 2 Way, Direct Acting, Brass Body, Seals: VITON Operating Temp -5 to 150 deg. C Operating Pressure: 140 PSI Coil: F Class, IP65, 100% ED Service: Air, Water, Steam
	VX2120-1/4		1/4	0.33				
	VX2120-3/8		3/8	4				
	VX2120-1/2		1/2	4				
	VXF2120-1/8		1/8				Voltage Options: 1 = 12 VDC 2 = 24VDC 2A=24VAC 3 = 110VAC 4 = 220VAC	Normally Closed, 2 Way, Direct Acting, Seals: NBR (Option: VITON) Operating Temp: -5 to 150 deg. C Operating Pressure: 150 PSI Coil: F Class, IP65, 100% ED Service: Air, Liquid Body Material: Aluminum
	VXF2120-1/4		1/4					
	VXF2120-3/8		3/8					
	VXF2120-1/2		1/2					
	QWO-1/2	\$112.00	1/2	4.8	Pilot Pressure: 80-150 PSI	Normally Open 2 Way, Direct Acting, Brass Body; Seals: Viton Operating Temp -5 to 80 deg. C Operating Pressure: 100 PSI Air Pilot Pressure: 80-150 PSI Service: Air, Water, Oil, Gas		
	QWO-3/4	\$132.00	3/4	7.6				
	QWO-1	\$162.00	1	12				
	QWO-1 1/2	\$242.15	1 1/2	29				
	QWO-2	\$302.70	2	48				



Electrical Coil List Price

	Part No.	Price	Voltage Options	Electrical Connection	Power	Specifications
	2W200C	\$23.10	1 = 12 VDC 2 = 24VDC 2A=24VAC 3 = 110VAC 4 = 220VAC Insulation: F Class IP65 Duty Cycle: 100% ED	D = DIN (5/16" strain relief connector) D = DIN (with LED indicator) G = Grommet (12" Lead Wire)	13 to 20W	For 2S/2W 025 to 250 series valves
	2W350C	\$35.75			25-65W	For 2/S2W 350-500 & 2L 170-500 series valves
	2WOC	\$29.70			40 W	For 2SO/2WO 160-500 series valves
	200C	\$7.92			3 to 6.5 W	For 2V & 2P025-035 & 2V1, 3V1 series valves

Solenoid Valve Specifications

Valve Type	2P	2S/2SO	2W/2WO	2L Series	VX Series 06 to 08	VX Series 10-15	QW
Operating Pressure	-28" Hg to 150 PSI @30 Deg. C			0 to 210 PSI	0 to 145 PSI	0 to 145 PSI	0 to 85 PSI
Operating Temperature	-5 TO 80 Deg. C			-5 TO 150 Deg. C	-5 TO 150 Deg. C	-5 TO 80 Deg. C	-5 TO 100 Deg. C
Body Materials	Engineered Plastic	304 Stainless	Brass	Brass	Brass	Brass	Brass
Seal Materials	NBR			PTFE	NBR		
Coil Protection Insulation Class	F Class IP65						Air Pilot Operated
Coil Duty Cycle	100% ED						
Electrical Connections	DIN (with 3/8" Strain Relief Connection)				Two 12" Lead Wires		N/A
Service	Vacuum, Air, Liquid (Reverse flow direction for vacuum applications)			Air, Liquid, Steam Installation -Vertical		Vacuum, Air, Liquid Air, Liquid, Gas	

STC Valve List Price

								
Reduced Port Ball Valves	Full Port Ball Valves	Full Port Ball Valves	Full Port Ball Valves	Full Port Butterfly Valves	Needle Valves			
Model	V1	V2	V3	V3C	VBS01	VN01		
Material	316 SS	316 SS	316 SS	316 SS	316 SS	316 Stainless Steel		
Port	FNPT	FNPT	FNPT	Clamp	Clamp	NPT Female		
Size 1/4"	V1-1/4	\$8.07	V2-1/4	\$12.21	V3-1/4	\$20.17		
3/8"	V1-3/8	\$8.43	V2-3/8	\$14.13	V3-3/8	\$20.17		
1/2"	V1-1/2	\$8.43	V2-1/2	\$14.13	V3-1/2	\$20.17		
3/4"	V1-3/4	\$12.27	V2-3/4	\$20.57	V3-3/4	\$29.03		
1"	V1-1	15.83	V2-1	\$28.67	V3-1	\$37.13	V3C-1	\$40.83
1 1/4"	V1-1 1/4	25.87	V2-1 1/4	\$42.37	V3-1 1/4	\$56.17		
1 1/2"	V1-1 1/2	\$31.67	V2-1 1/2	\$60.53	V3-1 1/2	\$70.53	V3C-1 1/2	\$79.20
2"	V1-2	40.23	V2-2	\$73.70	V3-2	\$100.90	V3C-2	\$111.00
3"							V3C-3	\$327.17
								
Miniature Ball Valves	Miniature Ball Valves	Full Port	ROTARY PNEUMATIC VALVE ACTUATORS		Single Acting	Double Acting	Note	
Model	T400	T400FM	T101L	KT-DA	Rotation		Suitable for Ball Valve Size	
Material	Chrome-Plated Brass	Chrome-Plated Brass	Brass		Model	Bore (mm)		
Port	F NPT	F x M NPT	F NPT					
Size 1/4"	T400-1/4	\$2.15	T400FM-1/4		\$2.15	T101L-1/4	\$2.72	1"
3/8"	T400-3/8	\$2.48	T400FM-3/8		\$2.48	T101-3/8		1 1/2"
1/2"	T400-1/2	\$2.90	T400FM-1/2		\$2.90	T101L-1/2	\$4.22	3"
3/4"						T101L-3/4	\$6.33	4"
1"						T101L-1	\$10.46	
1 1/2"						T101L-1 1/2	\$21.89	
2"						T101L-2	\$36.14	



STC Valve Technical Data

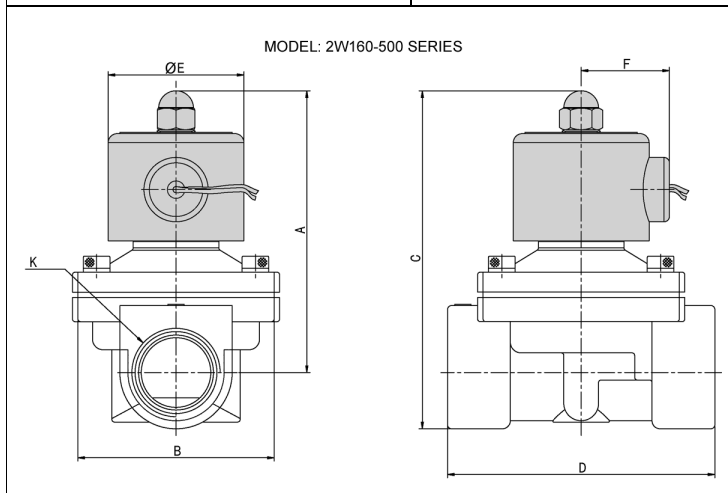
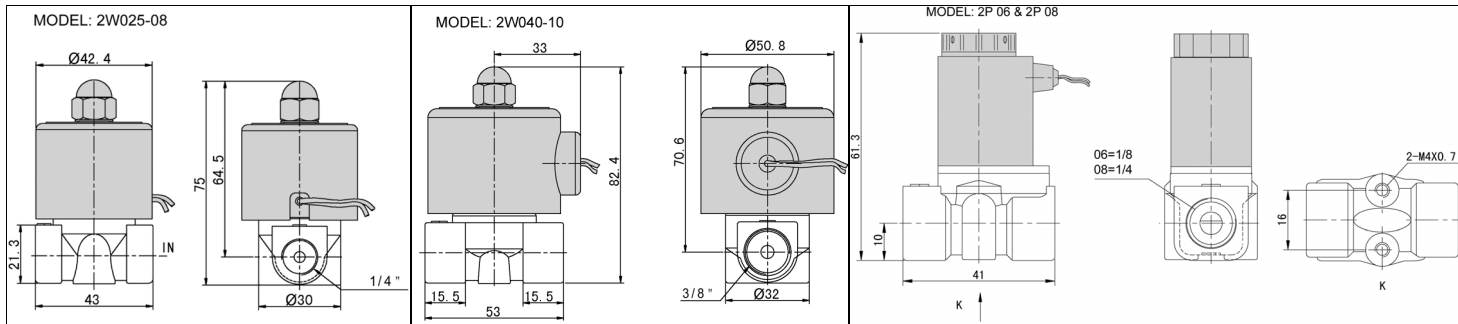

MODEL: 2S & 2W Series (MM)							
		A	B	C	D	E	F
2S160-3/8	2W160-3/8	101.5	57	117	69	50	36
2S160-1/2	2W160-1/2	101.5	57	117	69	50	36
2S200-3/4	2W200-3/4	107.0	57	124	73	50	36
2S250-1	2W250-1	111.5	74	135	99	50	36
2S350-1 1/4	2W350-1 1/4	142.0	95	172	123	70.5	56
2S400-1 1/2	2W400-1 1/2	142.0	95	172	123	70.5	56
2S500-2	2W500-2	172.0	123	209	168	70.5	56

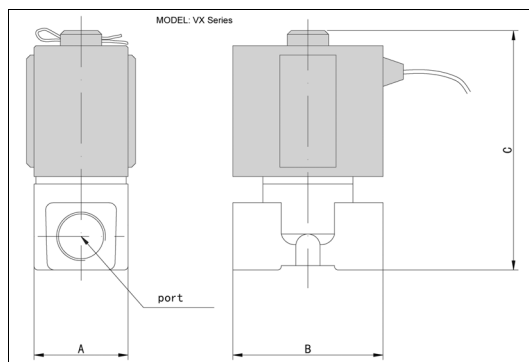

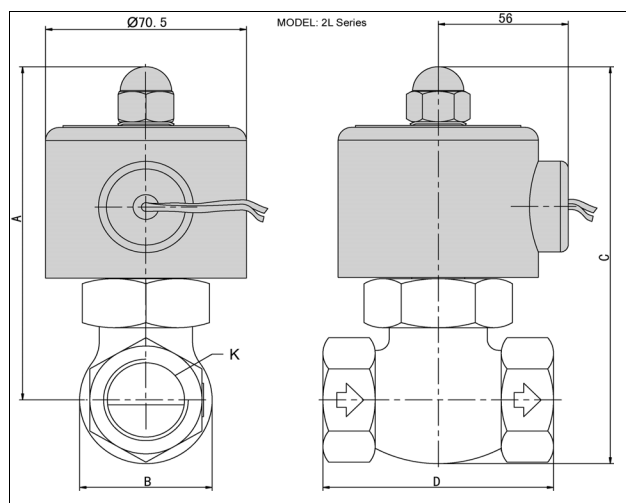

MODEL: VX Series (MM)				
	Port (NPT)	A	B	C
VX2120-1/8	1/8	25	40	64
VX2120-1/4	1/4	25	40	64
VX2120-3/8	3/8	48	68	110
VX2120-1/2	1/2	48	68	110

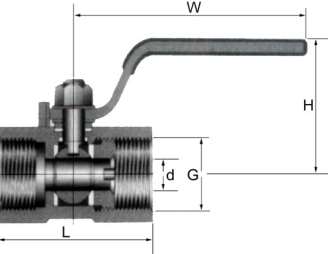

MODEL: 2L Series (MM)					
	A	B	C	D	K
2L170-3/8	125	42	146	82	3/8
2L170-1/2	125	42	146	82	1/2
2L170-3/4	125	42	146	82	3/4
2L200-1	136	52	162	91	1
2L300-1 1/4	148	74	185	111	1 1/4
2L300-1 1/2	148	74	185	111	1 1/2
2L500-2	176	86	223	163	2

STC Valve Technical Data

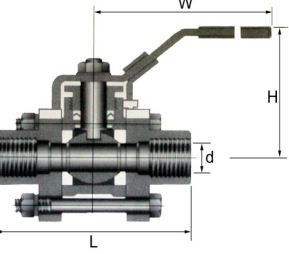
		Model: V1 SPECIFICATIONS						MAIN PARTS AND MATERIALS									
		One Piece Reduced Port 316 Stainless Steel Ball Valve						NO	PART NAME	MATERIAL	QTY						
		Maximum Operating Pressure: 1000 PSIG @ 100°F WOG*						1	SEAT	PTFE	2						
		Operating Temperature Range: -60 to 450°F*						2	BALL	SS316	1						
		End Connections: NPT Threaded with Padlocking device						3	JOINT GASKET	PTFE	1						
		DIMENSIONS (mm)						4	CAP	SS316	1						
SIZE	d	L	H	W	Wt (kg)		5	BODY	SS316/CF8M	1							
1/4"	5	39	35	64	0.07		6	STEM	SS316	1							
3/8"	7	44	37	70	0.1		7	THRUST WASHER	PTFE	1							
1/2"	9.2	56.5	43.5	90	0.16		8	STEM PACKING	PTFE	1							
3/4"	12.5	58	47	90	0.25		9	GLAND NUT	SS304	1							
1"	15	70	50	103	0.43		10	STEM WASHER	SS304	1							
1 1/4"	20	78	57	103	0.7		11	STEM NUT	SS304	1							
1 1/2"	24.5	83	69	127	0.83		12	HANDLE COVER	PLASTIC	1							
2"	32	100	74.5	127	1.5		13	HANDLE	SS304	1							
		Model: V2 SPECIFICATIONS										MAIN PARTS AND MATERIALS					
		Two Piece Full Port 316 Stainless Steel Ball Valve										NO	PART NAME	MATERIAL	QTY		
		Maximum Operating Pressure: 1/4" to 2" 1000 PSIG @ 100°F WOG* 2 1/2" to 3" 800 PSIG @ 100°F WOG*										1	SEAT	PTFE	2		
		Temperature Range: -60 to 450°F*										2	BALL	SS316	1		
		End Connections: NPT Threaded with Padlocking & panel mount device										3	JOINT GASKET	PTFE	1		
		DIMENSIONS (mm)										4	CAP	SS316	1		
SIZE	1/4"	3/8"	1/2"	3/4"	1"	1 1/4"	1 1/2"	2"	2 1/2"	3"	NO	PART NAME	MATERIAL	QTY			
d	11.6	12.7	15	20	25.4	32	38	50.8	65	76	5	BODY	SS316/CF8M	1			
L	55	55	63.5	75	88	103	110	124	167	192	6	STEM	SS316	1			
H	48	48	50	57	69	73	83	92	136	149	7	THRUST WASHER	PTFE	1			
W	103	103	103	125	145	145	190	190	250	250	8	STEM PACKING	PTFE	1			
											9	GLAND NUT	SS304	1			
											10	STEM WASHER	SS304	1			
											11	STEM NUT	SS304	1			
											12	HANDLE COVER	PLASTIC	1			
											13	HANDLE	SS304	1			
		Model: V3 SPECIFICATIONS												MAIN PARTS AND MATERIALS			
		Maximum Operating Pressure: 1/2" to 2" 1000 PSI @ 100°F WOG* 2 1/2" to 3" 800 PSI @ 100°F WOG*												NO	PART NAME	MATERIAL	QTY
		Temperature Range: -60 to 450°F*												1	SEAT	PTFE	2
		Full Port												2	BALL	SS316	1
		End Connections: FNPT												3	JOINT GASKET	PTFE	1
		Mounting Options: Padlocking device and actuator mounting bracket												4	CAP	SS316	1
		DIMENSIONS (mm)												5	BODY, BODY CONNECTOR	SS316/ CF8M	1, 2
		SIZE	1/4"	3/8"	1/2"	3/4"	1"	1 1/4"	1 1/2"	2"	2 1/2"	3"	4"	6	STEM	SS316	1
d	mm	12.5	12.5	15	20	25	30	38	50	64	80	98	7	THRUST WASHER	PTFE	1	
	in	0.49	0.49	0.59	0.79	0.98	1.18	1.5	1.97	2.52	3.15	3.86	8	STEM PACKING	PTFE	1	
H	mm	57	57	68	70	80	84	93	100	142	155	172	9	GLAND NUT	SS304	1	
	in	2.24	2.24	2.68	2.76	3.15	3.31	3.66	3.94	5.59	6.1	6.77	10	STEM WASHER	SS304	1	
W	mm	96	96	124	124	142	142	202	202	250	250	300	11	STEM NUT	SS304	1	
	in	3.78	3.78	4.88	4.88	5.59	5.59	7.95	7.95	9.84	9.84	11.81	12	HANDLE COVER	PLASTIC	1	
L	mm	68	68	72	83	90	112	120	147	174	193	216	13	HANDLE	SS304	1	
	in	2.56	2.56	2.84	3.35	3.62	4.33	4.48	5.59	6.85	7.6	8.5	14	BODY CONNECTOR BOLT	SS304	4	
													15	BODY CONNECTOR NUT & WASHER	SS304	4	

* Refer to Maximum Operating Pressure -Temperature Data on Page 8 for more information



STC Valve Technical Data

Solenoid & Process Valves

Image	Diagram	Model: VBS01 SPECIFICATIONS						MAIN PARTS AND MATERIALS		
		NO	PART NAME	MATERIAL						
		Size: 1/2" to 4"						NO		
		Full Port						PART NAME		
		Connection Options: Butt weld, Clamp, or Male Thread, Female Ends (RJT, IDF, DIN, SMS)						MATERIAL		
		Operating Pressure: -13 PSIG to 150 PSIG WOG*						1	BODY	SS316 or SS316L
		Temperature Range: -10°C to 150°C with Silicone, or Viton*						2	STEM WASHER	SS304
		Disc Head Size: 9.4 mm (to fit actuator)						3	STEM NUT	SS304
		Operator Options: Lever, Actuators						4	HANDLE	304 SS/Plastic
		Body Material Options: 316SS, or 316L SS						5	GASKET	Silicone, EPDM, or Viton
		Handle: 304 SS/Plastic						6	BODY CONNECTOR BOLT	SS304
		Seat Options: Silicone, EPDM or Viton						7	BODY CONNECTOR NUT & WASHER	SS304
		DIMENSIONS (mm)						8	BUTTERFLY	SS316/SS316L
		A	B	B	B	C	D	E		
		Size	Weld	Clamp	Bevel					
		1"	47.63	88.9	122.24	100	74	39		
		1 1/2"	47.63	88.9	134.94	110	47	39		
		2"	52.39	95.25	163.51	110	83.5	49.5		
		2 1/2"	53.98	96.84	174.63	110	93	58.5		
		3"	61.91	104.78	196.26	159	98	66		
		4"	79.38	122.24	228.6	159	118	84.5		

Image	Diagram	Model: V3C SPECIFICATIONS						MAIN PARTS AND MATERIALS						
		NO	PART NAME	MATERIAL	QTY									
		Sanitary Stainless Steel Ball Valve: These valves are made with precision machined Teflon seat for use in Sanitary applications. They are three piece design and have four bolts that permit quick and easy access to service the valve without disrupting the pipe line connections.						NO						
		Maximum Operating Pressure: 1/2" to 2" 1000 PSI @ 100°F WOG* 2 1/2" to 4" 800 PSI @ 100°F WOG*						PART NAME						
		Temperature Range: -60 to 450°F*						MATERIAL						
		Full Port						1	SEAT	PTFE	2			
		End Connections: Clamp End						2	BALL	SS316	1			
		Mounting Options: Padlocking device and actuator mounting bracket						3	JOINT GASKET	PTFE	1			
		DIMENSIONS (mm)						4	CAP	SS316	1			
		SIZE	PORT (d)	L	A	A1	H	T1	T2	W	5	BODY, BODY CONNECTOR	SS316/CF8M	1, 2
		1/2"	9.6	75	25	20.24	64	--	3.63	125	6	STEM	SS316	1
		3/4"	15.9	90	25	20.24	67	--	3.63	125	7	THRUST WASHER	PTFE	1
		1"	22.2	100	50.4	43.6	83	2.85	4.75	140	8	STEM PACKING	PTFE	1
		1 1/4"	28.5	110	50.4	43.6	89	2.85	4.75	140	9	GLAND NUT	SS304	1
		1 1/2"	34.9	125	50.4	43.6	100	2.85	--	200	10	STEM WASHER	SS304	1
		2"	47.5	150	63.9	56.3	108	2.85	--	200	11	STEM NUT	SS304	1
		2 1/2"	60.2	190	77.4	70.6	150	2.85	--	250	12	HANDLE COVER	PLASTIC	1
		3"	72.9	220	90	83.3	161	2.85	--	250	13	HANDLE	SS304	1
		4"	97.4	270	118.9	110.3	180	2.85	--	250	14	CONNECTOR BOLT	SS304	4
								15	CONNECTOR NUT & WASHER	SS304	4			

Image	Diagram	Model: VN01 SPECIFICATIONS						MAIN PARTS AND MATERIALS			
		NO	PART NAME	MATERIAL							
		End Connections: NPT threaded ASME b1.20.1 DIN 2999 & BS21; ISO 228/1 & ISO 7/1						NO			
		Max. Operating Pressure: 6000 PSIG @ 100 °F*						PART NAME			
		Operating Temperature Range: -60 to 450°F*						MATERIAL			
		Fire safe design						1	SET SCREW	SS304	
		DIMENSIONS (mm)						2	HANDLE	SS410	
		SIZE	1/8"	1/4"	3/8"	1/2"	3/4"	1"	3	STEM	SS316
		A	75	75	75	87	90	103	4	GLAND NUT	SS304
		B	25	25	25	30	32.5	40	5	GLAND	SS304
		C	50	50	50	60	65	80	6	PACKING	TEFLON
		Cv	0.43	0.43	0.74	1.36	2.64	3.6	7	BONNET	SS316/CF8M
								8	BODY	SS316/CF8M	

Valve Specifications			
Valve Type	T400	T400FM	T101L
Operating Pressure	200-800 PSI @ 90 °F		800 PSI @ 90 °F
Operating Temperature	-5 TO 80 Deg. C		
Body Materials	Chrome Plated Brass		Brass
Seal Materials	PTFE		
Service	Air, Liquid		

LIMITED WARRANTY – IMPORTANT NOTICE TO PURCHASER

Sizto Tech Corporation (STC) warrants only this product is be free from defects in materials and workmanship at the time of manufacture. This limited warranty expires one year after delivery to the end-user. STC's entire obligation to and the exclusive remedy of any party for breach of this limited warranty shall be limited to replacement of the defective product or refund of the original purchase price of this product, at STC's option. Purchaser has thirty (30) days to return the goods after STC has agreed to accept the return. All freight charges on returned material shall be paid by the Purchaser. STC's limited warranty shall not apply, however, to the product that have been subjected to misuse, alteration, accident or negligence during handling or storage.

DISCLAIMER OF IMPLIED WARRANTIES

All implied warranties, which may arise by implication of law or application of course of dealing or usage of trade, including, but not limited to, implied warranties of merchantability or fitness for a particular purpose are expressly excluded. There are no warranties, which extend beyond the description of the faced hereof. The end user is solely responsible for the suitability and fitness of this product selected for a particular application.

Distributed By



Sizto Tech Corporation

2284 Old Middlefield Way, Suite 8
Mountain View, CA 94043 USA
Tel: 650-938 8833, Fax: 650-938 8844
Email: Sales@StcValve.com; www.StcValve.com